

SECONDARY Ash BASIN PERMIT
REQUEST

DAQP. EX. 33

MWG13-15_9668



Mr. Mark Kelly
Midwest Generation EME, LLC
Powerton Power Station
13082 E Manito Road
Pekin, Illinois 61554

December 22, 2009
(1965)

RE: Transmittal of the Application for Permit or Construction Approval Supporting Documents
Midwest Generation Powerton Power Station Secondary Ash Settling Basin Liner Replacement

Dear Mark:

As requested, please find enclosed five (5) copies of the Application for Permit or Construction Approval cover letter and supporting documentation for Powerton Secondary Ash Settling Basin liner replacement. Please have Mike Hanrahan sign and date the application. I have enclosed an addressed, stamped envelope for you to return 4 of the 5 copies to me for submittal to IEPA. Please keep the 5th signed copy for your records.

Should you have any questions or comments please contact us. We appreciate the continued opportunity to support Midwest Generation.

Sincerely,

NATURAL RESOURCE TECHNOLOGY, INC.

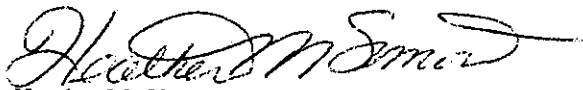
Heather M. Simon, PE
Project Manager

Enclosures: As Stated

[1965 MKelly Permit 0901222trans]

December 18, 2009

Mr. Jaime Rabins
Illinois Environmental Protection Agency
Division of Water Pollution Control
1021 North Grand Avenue East
P.O. Box 19276
Springfield, Illinois 62794-9276

RE: Application for Permit or Construction Approval
Secondary Ash Settling Basin Liner Replacement
Midwest Generation Powerton Power Station
13082 East Manito Road, Pekin, IL
NPDES Permit No. IL0002232

Dear Mr. Rabins,

Midwest Generation, LLC (MWG) is requesting a construction permit for liner replacement in the Secondary Ash Settling Basin at the Powerton Power Station. This activity is part of MWG's routine maintenance program for the facility; no significant modifications will be made to the basin's operation or treatment process. Please find enclosed a copy of the Application for Permit or Construction Approval WPC-PS-1 and supporting documents.

The following information is attached:

- A site location map is included in the "Figure" tab;
- A plan view of existing conditions, liner replacement plan, cross section and details drawings are included in the "Sheets" tab;
- Form WPC-PS-1 "Application for Permit or Construction Approval", and Schedules G "Sludge Disposal & Utilization", J "Industrial Treatment Works Construction or Pretreatment Works", and N "Waste Characteristics" are provided in Appendix A;
- Representative photographs of the Secondary Ash Settling Basin are provided in Appendix B; and
- Specification Section 02600 for installation of high-density polyethylene (HDPE) geomembrane liner is provided in Appendix C.

235 Remington Blvd.
Suite A
Bolingbrook, IL 60440
Tel: 630 771 7862
Fax: 312 788 5526
mrace@mwgen.com

FACILITY DESCRIPTION

The Secondary Ash Settling Basin operates continuously for settling of solid/coal ash waste associated with electrical power generation that discharges from the Primary Ash Settling Basin at the station. Currently, the basin is lined with chlorosulfonated polyethylene (Hypalon®) liner. The total depth of the basin is 18 feet with a working volume of approximately 8.1 million gallons and a design maximum flow (DMF) of 32.4 million gallons per day (MGD). Typically, the basin freeboard is 7 feet during operation. Photographs of the current condition of the basin are provided in Appendix B.

PROJECT DESCRIPTION

The Secondary Ash Settling Basin at the Powerton Generating Station will undergo a liner upgrade by the addition of a 60 mil HDPE geomembrane liner above the existing Hypalon® liner along side slopes and base of basin. Liner replacement activities for the Secondary Ash Settling Basin are anticipated to occur in April and May 2010, with dredging activities occurring in April (dewatering followed by dry excavation).

During dewatering and dredging activities in April 2010 at the Secondary Ash Settling Basin, the flow from the Primary Ash Settling Basin will be temporarily diverted to the IEPA approved overflow area (Old Ash Basin) for the basin, as described in the station's NPDES permit. The station is scheduled to be shutdown for maintenance between May 4 and May 29, 2010. Installation of the replacement liner is scheduled to occur during station shutdown since wastewater is not expected to be generated and discharged to the ash settling basins for treatment. This schedule may change based upon plant operation needs. Liner replacement activities will include:

- Subgrade preparation for HDPE geomembrane liner (Sheet C020), including placement and removal of temporary access ramp for removal of 30 years of accumulated ash and sediment at the base of the basin;
- Deployment and seaming of the HDPE geomembrane replacement liner. The permeability¹ of geomembrane is typically between 2×10^{-13} and 4×10^{-13} centimeters per second.

The proposed HDPE geomembrane replacement liner and associated anchor trench are shown on Sheet C030. Cross sections and details associated with the liner are shown on Sheets C031.

Once complete the liner system will consist of the existing Hypalon liner and the new 60 mil HDPE geomembrane liner.

¹ Koerner, Robert M., and David E. Daniel, *Final Covers for Solid Waste Landfills and Abandoned Dumps*, ASCE Press, 1997

Mr. Jaime Rabins, Div. of Water Pollution Control, IEPA
December 17, 2009
Page 3

If you have any questions or require additional information as you review this application, please call me at 312-583-6062.

Sincerely,

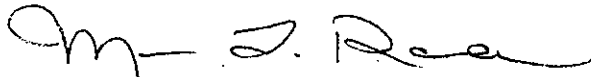

Maria Race
Environmental Program Manager

Attachments: Figure 1 – Site Location Map
Appendix A – WPC-PS-1 and Schedules G, J and N
Appendix B – Site Photographs
Appendix C – Specification Section 02600, HDPE Geomembrane
Sheet C010 – Existing Conditions
Sheet C020 – Liner Subgrade Preparation
Sheet C030 – Warning Layer Plan
Sheet C031 – Details and Sections

cc: Mr. Mark Kelly, MWG-Powerton

MWG13-15_9672

FIGURES

FIGURES

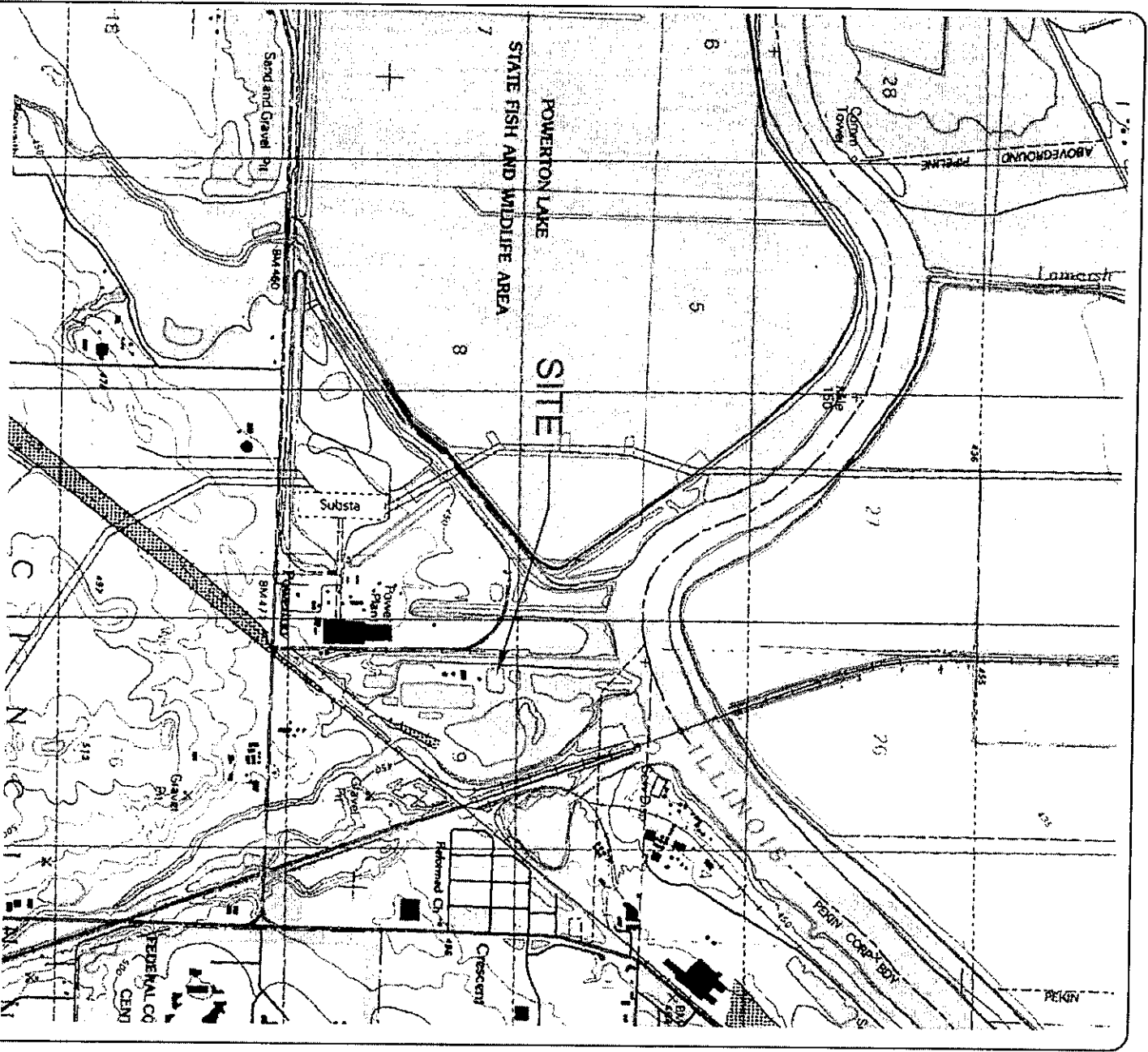

SOURCE: USGS 7.5 MINUTE QUADRANGLE,
PEKIN, ILLINOIS, DATED 1996.

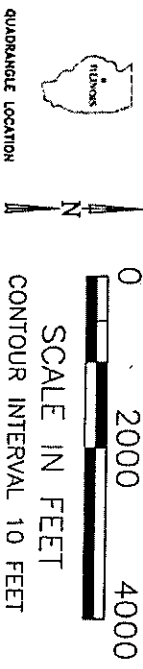

QUADRANGLE LOCATION



NATURAL
RESOURCE
TECHNOLOGY

SITE LOCATION MAP

SECONDARY ASH SETTLING BASIN LINER REPLACEMENT
MIDWEST GENERATION
POWERTON POWER STATION
PEKIN, ILLINOIS

PROJECT NO.
1965/5.2

DRAWING NO.
1965-52-A01C

FIGURE NO.
1

DRAWN BY: KWW 07/27/09 APP'D BY: RJG DATE: 12/07/09

MWCG13-15_9675

APPENDIX A

APPENDIX A

**APPLICATION FOR PERMIT OR CONSTRUCTION
APPROVAL**

(WPC-PS-1 and Schedules G, J, and N)



Illinois Environmental Protection Agency
 Permit Section, Division of Water Pollution Control
 P.O. Box 19276
 Springfield, Illinois 62794-9276

For IEPA Use:

**Application for Permit or Construction Approval
 WPC-PS-1**

1. Owner Name: Midwest Generation EME, LLC
 Name of Project: Powerton Secondary Ash Settling Basin Liner Replacement
 Township: Pekin County: Tazewell

2. Brief Description of Project:
Maintenance on Secondary Ash Settling Basin includes replacement of the basin liner. There will be no significant changes to current operation of the pond.

3. Documents Being Submitted: If the Project involves any of the items listed below, submit the corresponding schedule, and check the appropriate boxes.

	<u>Schedule</u>		<u>Schedule</u>
Private Sewer Connection/Extension	A/B <input type="checkbox"/>	Spray Irrigation	H <input type="checkbox"/>
Sewer Extension Construct Only	C <input type="checkbox"/>	Septic Tanks	I <input type="checkbox"/>
Sewage Treatment Works	D <input type="checkbox"/>	Industrial Treatment/Pretreatment	J <input checked="" type="checkbox"/>
Excess Flow Treatment	E <input type="checkbox"/>	Waste Characteristics	N <input checked="" type="checkbox"/>
Lift Station/Force Main	F <input type="checkbox"/>	Erosion Control	P <input type="checkbox"/>
Fast Track Service Connection	FTP <input type="checkbox"/>	Trust Disclosure	T <input type="checkbox"/>
Sludge Disposal	G <input checked="" type="checkbox"/>		

Plans: Title Secondary Ash Settling Basin Liner Replacement, Midwest Generation, Powerton Power Station,
Pekin, IL No. of Pages: 4

Specifications: Title Section 02600, High Density Polyethylene (HDPE) Geomembrane
 No. of Books/Pages: 21

Other Documents: Facility photos (see attached)
 (Please Specify)

3.1 Illinois Historic Preservation Agency approval letter: Yes No
 4. Land Trust: Is the project identified in item number 1 herein, for which a permit is requested, to be constructed on land which is the subject of a trust? Yes No

If yes, Schedule T (Trust Disclosure) must be completed and item number 7.1.1 must be signed by a beneficiary, trustee or trust officer.

5. This is an Application for (Check Appropriate Line):
 A. Joint Construction and Operating Permit
 B. Authorization to Construct (See Instructions) NPDES Permit No. IL00 02232
 C. Construct Only Permit (Does Not Include Operations)
 D. Operate Only Permit (Does Not Include Construction)

6. Certifications and Approval:

6.1 Certificate by Design Engineer (When required: refer to instructions)

I hereby certify that I am familiar with the information contained in this application, including the attached schedules indicated above, and that to the best of my knowledge and belief such information is true, complete and accurate. The plans and specifications (specifications other than Standard Specifications or local specifications on file with this Agency) as described above were prepared by me or under my direction.

Engineer Name: Heather M. Simon

Registration Number: 062 - 060491
(3 digits) (6 digits)

Firm: Natural Resource Technology, Inc.

Address: 23713 W. Paul Rd, Suite D

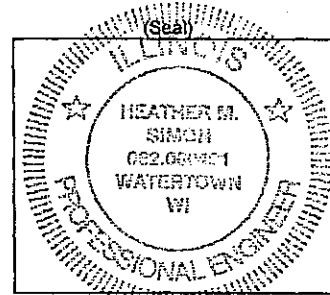

City: Pewaukee State: WI Zip: 53072 Phone No: _____

Signature X: *Heather M. Simon* Date: 12/23/09

7. Certifications and Approvals for Permits:

7.1 Certificate by Applicant(s)

I/We hereby certify that I/we have read and thoroughly understand the conditions and requirements of this Application, and am/are authorized to sign this application in accordance with the Rules and Regulations of the Illinois Pollution Control Board. I/We hereby agree to conform with the Standard Conditions and with any other Special Conditions made part of this Permit.

7.1.1 Name of Applicant for Permit to Construct: Midwest Generation EME, LLC

Address: 13082 E Manito Road

City: Pekin State: IL Zip Code: 61554

Signature X: *Jeff Kickart* Date: 12-30-09

Printed Name: Mike Hamrahan Jeff Kickart Phone No: 309 477 5216

Title: Assistant Station Director

Organization: _____

7.1.2 Name of Applicant for Permit to Own and Operate: Same as above

Address: _____

City: _____ State: _____ Zip Code: _____

Signature X _____ Date: _____

Printed Name: _____ Phone No: _____

Title: _____

7.2 Attested (Required When Applicant is a Unit of Government) N/A

Signature X _____ Date: _____

Title: _____
(City Clerk, Village Clerk, Sanitary District Clerk, Etc.)

7.3 Applications from non-governmental applicants which are not signed by the owner, must be signed by a principal executive officer of at least the level of vice president, or a duly authorized representative.

7.4 Certificate By Intermediate Sewer Owner N/A

I hereby certify that (Please check one):

- 1. The sewers to which this project will be tributary have adequate reserve capacity to transport the wastewater that will be added by this project without causing a violation of the environmental Protection Act or Subtitle C, Chapter I, or
- 2. The Illinois Pollution Control Board, in PCB _____ dated _____ granted a variance from Subtitle C, Chapter I to allow construction of facilities that are the subject of this application.

Name and location of sewer system to which this project will be tributary:

Sewer System Owner: _____

Address: _____

City: _____ State: _____ Zip Code: _____

Signature X _____ Date: _____

Printed Name: _____ Phone No: _____

Title: _____

7.4.1 Additional Certificate By Intermediate Sewer Owner N/A

I hereby certify that (Please check one):

- 1. The sewers to which this project will be tributary have adequate reserve capacity to transport the wastewater that will be added by this project without causing a violation of the environmental Protection Act or Subtitle C, Chapter I, or
- 2. The Illinois Pollution Control Board, in PCB _____ dated _____ granted a variance from Subtitle C, Chapter I to allow construction facilities that are the subject of this application.
- 3. Not applicable

Name and location of sewer system to which this project will be tributary:

Sewer System Owner: _____

Address: _____

City: _____ State: _____ Zip Code: _____

Signature X _____ Date: _____

Printed Name: _____ Phone No: _____

Title: _____

7.5 Certificate By Waste Treatment Works Owner N/A

I hereby certify that (Please check one):

- 1. The waste treatment plant to which this project will be tributary has adequate reserve capacity to treat the wastewater that will be added by this project without causing a violation of the Environmental Protection Act or Subtitle C, Chapter I, or
- 2. The Illinois Pollution Control Board, in PCB _____ dated _____ granted a variance from Subtitle C, Chapter I to allow construction and operation of the facilities that are the subject of this application.
- 3. Not applicable

I also certify that, if applicable, the industrial waste discharges described in the application are capable of being treated by the treatment works.

Name of Waste Treatment Works: _____

Waste Treatment Works Owner: _____

Address: _____

City: _____ State: _____ Zip Code: _____

Signature X _____ Date: _____

Printed Name: _____ Phone No: _____

Title: _____

Please return completed form to the following address:

Illinois Environmental Protection Agency
Permit Section, Division of Water Pollution Control
P.O. Box 19276
Springfield, Illinois 62794-9276

This Agency is authorized to require this information under Illinois Revised Statutes, 1979, Chapter 111 ½, Section 1039. Disclosure of this information is required under that Section. Failure to do so may prevent this form from being processed and could result in your application being denied. This form has been approved by the Forms Management Center.

This Agency is authorized to require this information under Illinois Revised Statutes, 1979, Chapter 111 1/2, Section 1039. Disclosure of this information is required under that section. Failure to do so may prevent this form from being processed and could result in your application being denied.

For IEPA Use:

LOG #

DATE RECEIVED:

**ILLINOIS ENVIRONMENTAL PROTECTION AGENCY
DIVISION OF WATER POLLUTION CONTROL
PERMIT SECTION
Springfield, Illinois 62794-9276**

SCHEDULE G SLUDGE DISPOSAL & UTILIZATION

1. Name of Project Powerton Secondary Ash Settling Basin Liner Replacement
2. General Information
 - 2.1 Source(s) Coal Ash from power generation station
 - 2.2 Production Volume per year 1500 tons (estimated) Dry Tons per year NA
(one time occurrence in 30 years)
 - 2.3 Sludge to be disposed of is: Liquid NA Dry Tons NA
 - 2.4 Sludge is: Aerobically digested , Anaerobically digested , Heat Anaerobically digested , Raw , Chemically Stabilized , Composted , Wastewater Lagoon , WTP Lime , WTP Alum , WTP Iron , Other ,
If other, describe Coal Ash . Mixture , If mixture, describe _____
 - 2.5 Is the sludge defined as hazardous by State or Federal Law? YES NO . If yes, basis. _____
 - 2.6 Is sludge to be stored on the STP site? YES NO If yes, type of storage, lagoon , storage tank ,
Other . If other, describe _____ capacity of storage, _____ cu. ft.
 - 2.7 Sludge Hauling
 - 2.7.1 Name(s), address(es) and Illinois Transporters I.D. Numbers

Dave Clinard Trucking - DOT# 280869
Route 24 West; Mt. Sterling, IL 62353
 - 2.7.2 For industrial generators, has Illinois Generator ID Number and Authorization Number been issued? YES NO
If no, contact the Division of Land Pollution Control.

Illinois Generator ID Number ILD000665471
Authorization Number 9290-99
3. Methods of Sludge Disposal and/or Utilization
 - 3.1 Land Application
 - 3.1.1 Indicate the number of dry tons of sludge per year to be disposed by each of the following methods:
Agricultural land , Commercial Fertilizer Production , Dedicated Land Disposal , Disturbed Land Reclamation , Silviculture , Horticultural Lands , Public Distribution , Other ,
If other, specify _____
 - 3.1.2 Sludge Disposal Site Location. Provide a map (USGS Quadrangle map or plat map) showing location.

Name of USGS Quadrangle Map (7.5 or 15 minute) or plat map _____
 - 3.1.3 Provide soil survey map and soil description for disposal site. Identify name of soil survey and map sheet number for each soil survey map provided.

3.1.4 Is sludge to be stored at disposal site? YES NO . If yes, describe and state the storage volume NA cubic feet.

3.1.5 Provide a copy of sludge user information sheet and completed, signed copies for any known users.

3.1.6 In a narrative description provide operating practices and design features to prevent ground and/or surface water pollution, potable water supply wellhead protection and other buffer distances, calculations supporting storage capacity, total acres available, soil characteristics, operational contingencies, etc.

Disposed at Coal Mine:
Buckheart Mine
22116 E County 6 Hwy
Canton, IL 61520

3.1.7 Submit calculations of sludge application rate for agronomic rate, organic loading and metal loading rate.

3.2 Landfilling on-site off-site

3.2.1 Sanitary Landfill Special Waste Landfill Hazardous Waste Landfill Other

If other, specify _____

3.2.2 Name and Location of Landfill(s)

3.2.3 IEPA Permit Number(s) _____

3.3 Incineration

3.3.1 Name and Location NA

3.3.2 IEPA Permit Number(s) _____

3.3.3 Ultimate Disposal of Incinerator residue

4. Sludge Characteristics

Submit complete analyses of sludge characteristics in mg/kg dry wt. basis unless otherwise indicated. The analyses shall be performed unless the sludge is disposed of by incineration or at an off-site landfill. Analyses performed shall include but not be limited to parameters below:

Parameter

% TS
% VS
COD mg/l
pH
BOD₅ mg/l
Acidity meq of CaCO₃ at pH
Alkalinity meq of CaCO₃ at pH
Oil and Grease mg/l
Phenols mg/l
Cyanide
Sulfate (total) mg/l
Sulfide (total) mg/l
Sodium
EC mmhos/cm
TOC

Parameter

Sulfur
Aluminum (total)
Arsenic (total)
Barium (total)
Cadmium (total)
Cobalt (total)
Chromium, hex (total)
Chromium (total)
Copper (total)
Iron (total)
Mercury (total)
Manganese (total)
Molybdenum (total)
Nickel (total)
Lead (total)

Ammonia mg/l
Total Kjeldahl Nitrogen mg/l
Phosphorus
Potassium
% Volatile Acids, if anaerobically digested

Selenium (total)
Vanadium (total)
Zinc (total)
Radium 226 pCi/g
Radium 228 pCi/g
Other*

*Include results of any hazardous waste characteristics tests performed for: 1) EP Toxicity, 2) Corrosivity, 3) Ignitability, and 4) Reactivity.

IL 532-0016

WPC 156

MWG13-15_9684

ANALYTICAL REPORT

Job Number: 500-22894-1

Job Description: Powerton Basin Sampling

For:

Midwest Generation EME LLC
13082 E Manito Road
Pekin, IL 61554

Attention: Mr. Joe Heredia

Cindy Pritchard

Approved for release.
Cindy R Pritchard
Project Mgmt. Assistant
12/14/2009 12:35 PM

Designee for
Bonnie M Stadelmann
Project Manager II
bonnie.stadelmann@testamericainc.com
12/14/2009

cc: Mark Kelly
Ms. Maria Race

These test results meet all the requirements of NELAC for accredited parameters.

The Lab Certification ID# is 100201.
TestAmerica Portland OR00040

All questions regarding this test report should be directed to the TestAmerica Project Manager whose signature appears on this report. All pages of this report are integral parts of the analytical data. Therefore, this report should be reproduced only in its entirety.

TestAmerica Laboratories, Inc.
TestAmerica Chicago 2417 Bond Street, University Park, IL 60484
Tel (708) 534-5200 Fax (708) 534-5211 www.testamericainc.com



SAMPLE RESULTS

Mr. Joe Heredia
 Midwest Generation EME LLC
 13082 E Manito Road
 Pekin, IL 61554

Job Number: 500-22894-1

Client Sample ID: **SECONDARY ASH BASIN**
 Lab Sample ID: **500-22894-1**

Date Sampled: 12/02/2009 1300
 Date Received: 12/04/2009 1030
 Client Matrix: Solid

Analyte	Result/Qualifier	Unit	RL	Dilution
Method: TCLP-6010B		Date Analyzed:	12/08/2009 1656	
Prep Method: 3010A		Date Prepared:	12/08/2009 0930	
Arsenic	<0.050	mg/L	0.050	1.0
Barium	0.61	mg/L	0.50	1.0
Cadmium	<0.0050	mg/L	0.0050	1.0
Chromium	<0.025	mg/L	0.025	1.0
Lead	<0.050	mg/L	0.050	1.0
Selenium	<0.050	mg/L	0.050	1.0
Silver	<0.025	mg/L	0.025	1.0
Method: 6010B		Date Analyzed:	12/07/2009 2334	
Prep Method: 3050B		Date Prepared:	12/07/2009 0758	
Potassium	1900	mg/Kg	53	1.0
Sodium	2500	mg/Kg	110	1.0
Method: TCLP-7470A		Date Analyzed:	12/09/2009 1052	
Prep Method: 7470A		Date Prepared:	12/09/2009 0710	
Mercury	<0.0020	mg/L	0.0020	1.0
Method: Soluble-305.1		Date Analyzed:	12/09/2009 0749	
Acidity	<200	mg/Kg	200	1.0
Method: 9014		Date Analyzed:	12/09/2009 1447	
Prep Method: 9010B		Date Prepared:	12/09/2009 1100	
Cyanide, Total	<0.49	mg/Kg	0.49	1.0
Method: 9034		Date Analyzed:	12/11/2009 1401	
Prep Method: 9030B		Date Prepared:	12/11/2009 0925	
Sulfide	43	mg/Kg	27	1.0
Method: 9038		Date Analyzed:	12/08/2009 0001	
Prep Method: 300_Prep		Date Prepared:	12/06/2009 2231	
Sulfate	1700	mg/Kg	290	5.0
Method: 9045C		Date Analyzed:	12/08/2009 1432	
pH	7.24	SU	0.200	1.0
Method: 9066		Date Analyzed:	12/10/2009 0752	
Prep Method: Distill/Phenol		Date Prepared:	12/09/2009 1430	
Phenolics, Total Recoverable	<0.58	mg/Kg	0.58	1.0
Method: 9071B		Date Analyzed:	12/09/2009 1316	
Prep Method: 9071B		Date Prepared:	12/09/2009 0825	
HEM (Oil & Grease)	<560	mg/Kg	560	1.0

Mr. Joe Heredia
 Midwest Generation EME LLC
 13082 E Manito Road
 Pekin, IL 61554

Job Number: 500-22894-1

Client Sample ID: SECONDARY ASH BASIN
 Lab Sample ID: 500-22894-1

Date Sampled: 12/02/2009 1300
 Date Received: 12/04/2009 1030
 Client Matrix: Solid

Analyte	Result/Qualifier	Unit	RL	Dilution
Method: Lloyd Kahn TOC Dup	7700	mg/Kg	120	1.0
Date Analyzed: 12/11/2009 0956				
Method: Moisture Percent Moisture	13	%	0.10	1.0
Date Analyzed: 12/06/2009 2340				
Method: Soluble-SM 2320B Alkalinity	<530	mg/Kg	530	1.0
Date Analyzed: 12/08/2009 1002				
Method: SM 4500 NH3 C Prep Method: SM 4500 NH3 B Ammonia	160	mg/Kg	22	1.0
Date Analyzed: 12/10/2009 1149				
Date Prepared: 12/09/2009 1120				
Method: SM 4500 Norg C Prep Method: 351.3_Prep Nitrogen, Kjeldahl	270	mg/Kg	44	1.0
Date Analyzed: 12/07/2009 1636				
Date Prepared: 12/07/2009 1405				
Method: SM 4500 P E Prep Method: SM 4500 P B Phosphorus as P	470	mg/Kg	100	10
Date Analyzed: 12/10/2009 1411				
Date Prepared: 12/08/2009 1100				
Method: SM 5210B Biochemical Oxygen Demand	<23	mg/Kg	23	10
Date Analyzed: 12/04/2009 1605				
Method: SM 5220C Prep Method: SM 5220 Chemical Oxygen Demand	53000	mg/Kg	3400	10
Date Analyzed: 12/08/2009 1106				
Date Prepared: 12/07/2009 1520				

FOR IEPA USE:
LOG #
DATE RECEIVED:

ILLINOIS ENVIRONMENTAL PROTECTION AGENCY
DIVISION OF WATER POLLUTION CONTROL
PERMIT SECTION

Springfield, Illinois 62706

SCHEDULE J INDUSTRIAL TREATMENT WORKS CONSTRUCTION OR PRETREATMENT WORKS

1. NAME AND LOCATION:

1.1 Name of project Powerton Secondary Ash Settling Basin Liner Replacement

1.2 Plant Location

1.2.1 SW 9 Pekin R5W
Quarter Section Section Township Range P.M.
1.2.2 Latitude 40 deg. 32 min. 80 sec. "NORTH"
1.2.3 Longitude 89 deg. 40 min. 90 sec. "WEST"
1.2.3 Name of USGS Quadrangle Map (7.5 or 15 minute) _____

2. NARRATIVE DESCRIPTION AND SCHEMATIC WASTE FLOW DIAGRAM: (see instructions)

During installation of replacement liner, flow from the Primary Ash Settling Basin will be temporarily diverted to the Old Ash Basin. Water flows to the Secondary Ash Settling Basin from Primary Ash Settling Basin and Ash By-Pass Basin (as necessary), as shown on attached flow diagram.

2.1 PRINCIPAL PRODUCTS:

electrical power

2.2 PRINCIPAL RAW MATERIALS:

coal

3. DESCRIPTION OF TREATMENT FACILITIES:

3.1 Submit a flow diagram through all treatment units showing size, volumes, detention times, organic loadings, surface settling rate, weir overflow rate, and other pertinent design data. Include hydraulic profiles and description of monitoring systems.

3.2 Waste Treatment Works is: Batch , Continuous , No. of Batches/day _____ , No. of Shifts/day _____

3.3 Submit plans and specifications for proposed construction.

3.4 Discharge is: Existing ; Will begin on _____

4. DIRECT DISCHARGE IS TO: Receiving Stream Municipal Sanitary Sewer Municipal storm or municipal combined sewer

If receiving stream or storm sewer are indicated complete the following:

Name of receiving stream Old Intake Channel ; tributary to Illinois River ;

tributary to _____ ; tributary to _____ ;

5. Is the treatment works subject to flooding? Yes No If so, what is the maximum flood elevation of record (in reference to the treatment works datum) and what provisions have been made to eliminate the flooding hazard?

6. APPROXIMATE TIME SCHEDULE: Estimated construction schedule:

Start of Construction 04/01/10 ; Date of Completion 05/29/10 (station shutdown May 4 to May 29, 2010_

Operation Schedule _____ ; Date Operation Begins June 2010

100% design load to be reached by year _____

7. DESIGN LOADINGS

7.1 Design population equivalent (one population equivalent is 100 gallons of wastewater per day, containing 0.17 pounds of BOD₅ and 0.20 pounds of suspended solids;

BOD NA ; Suspended Solids NA ; Flow NA

7.2 Design Average Flow Rate 21.6 MGD.

MWG13-15_9689

- 7.3 Design Maximum Flow Rate 32.4 MGD.
- 7.4 Design Minimum Flow Rate 10.8 MGD.
- 7.5 Minimum 7-day, 10-year low flow NA cfs NA MGD.
Minimum 7-day, 10-year flow obtained from NA
- 7.6 Dilution Ratio NA ; _____

8. FLOW TO TREATMENT WORKS (if existing):

- 8.1 Flow (last 12 months)
 - 8.1.1 Average Flow 13.13 MGD
 - 8.1.2 Maximum Flow 32.4 MGD
- 8.2 Equipment used in determining above flows

9. Has a preliminary engineering report for this project been submitted to this Agency for Approval?

Yes No . If so, when was it submitted and approved. Date Submitted _____
 Certification # _____
 Dated _____

10. List Permits previously issued for the facility:

NPDES Permit No. IL0002232

11. Describe provisions for operation during contingencies such as power failures, flooding, peak loads, equipment failure, maintenance shut downs and other emergencies.

There is no equipment in the basin. Influent pumped to basin, so in the event of power failure or equipment malfunction, the flow of influent to the basin stops. In the event of an overflow from the Primary Ash Settling Basin the water is diverted to the Old Ash Basin.

12. Complete and submit Schedule G if sludge disposal will be required by this facility.

13. WASTE CHARACTERISTICS: Schedule N must be submitted.

14. TREATMENT WORKS OPERATOR CERTIFICATION: List names and certification numbers of certified operators:

Mark Kelly (see attached certification)

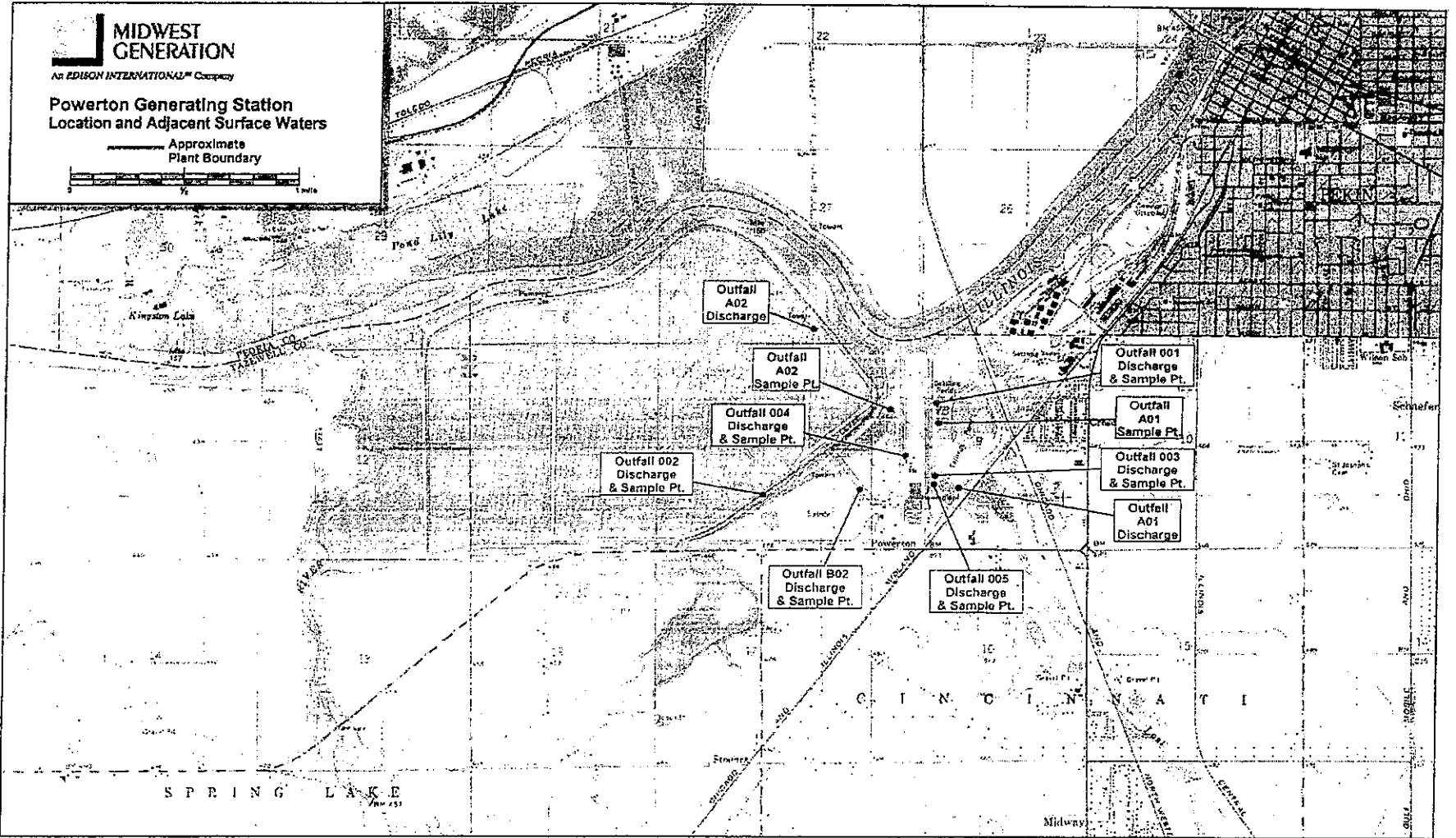

MWG13-15_9691

NPDES OUTFALLS

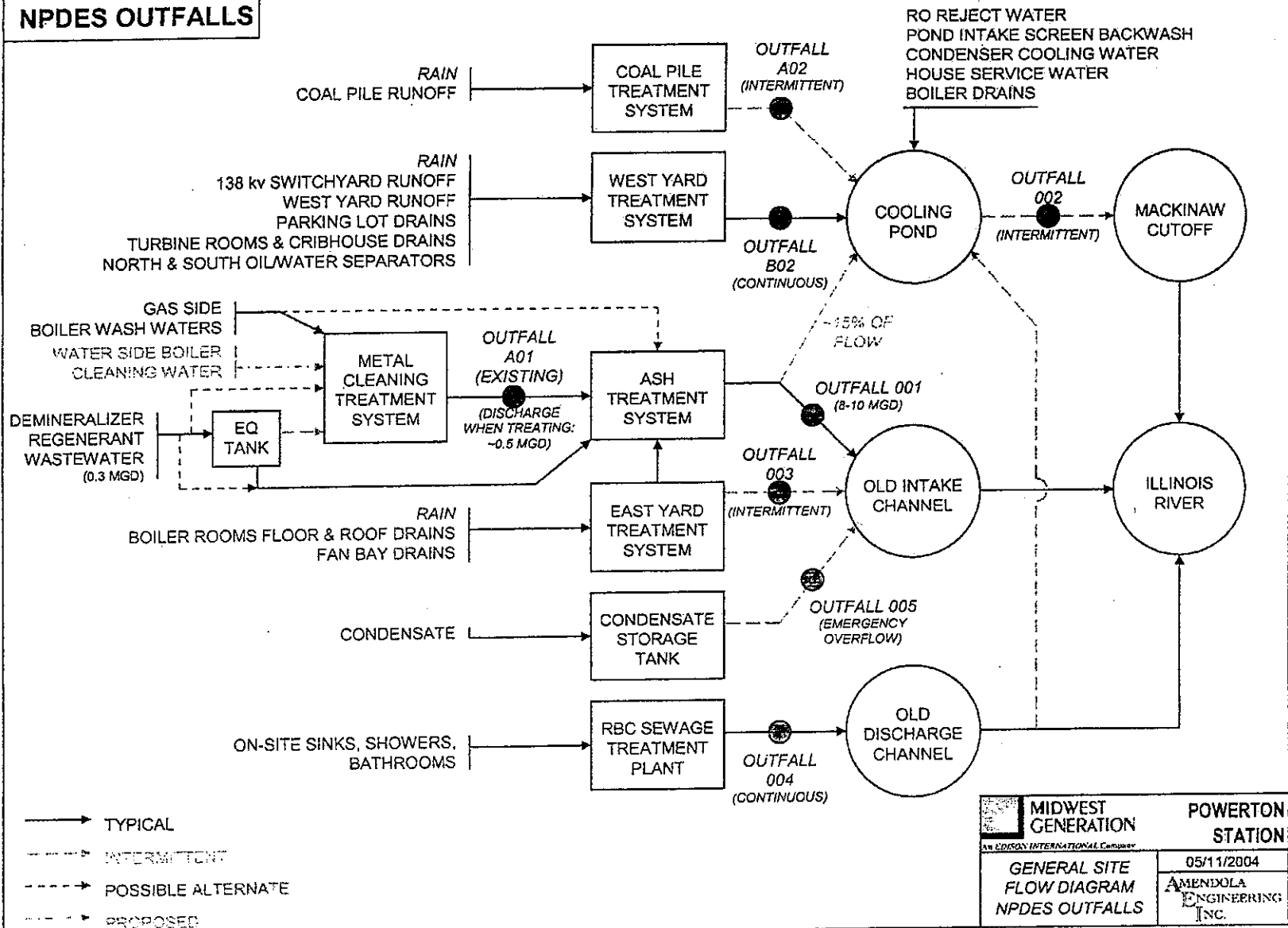

MIDWEST GENERATION <small>an EDISON INTERNATIONAL Company</small>	POWERTON STATION
	05/11/2004 AMENDOLA ENGINEERING INC.
GENERAL SITE FLOW DIAGRAM NPDES OUTFALLS	

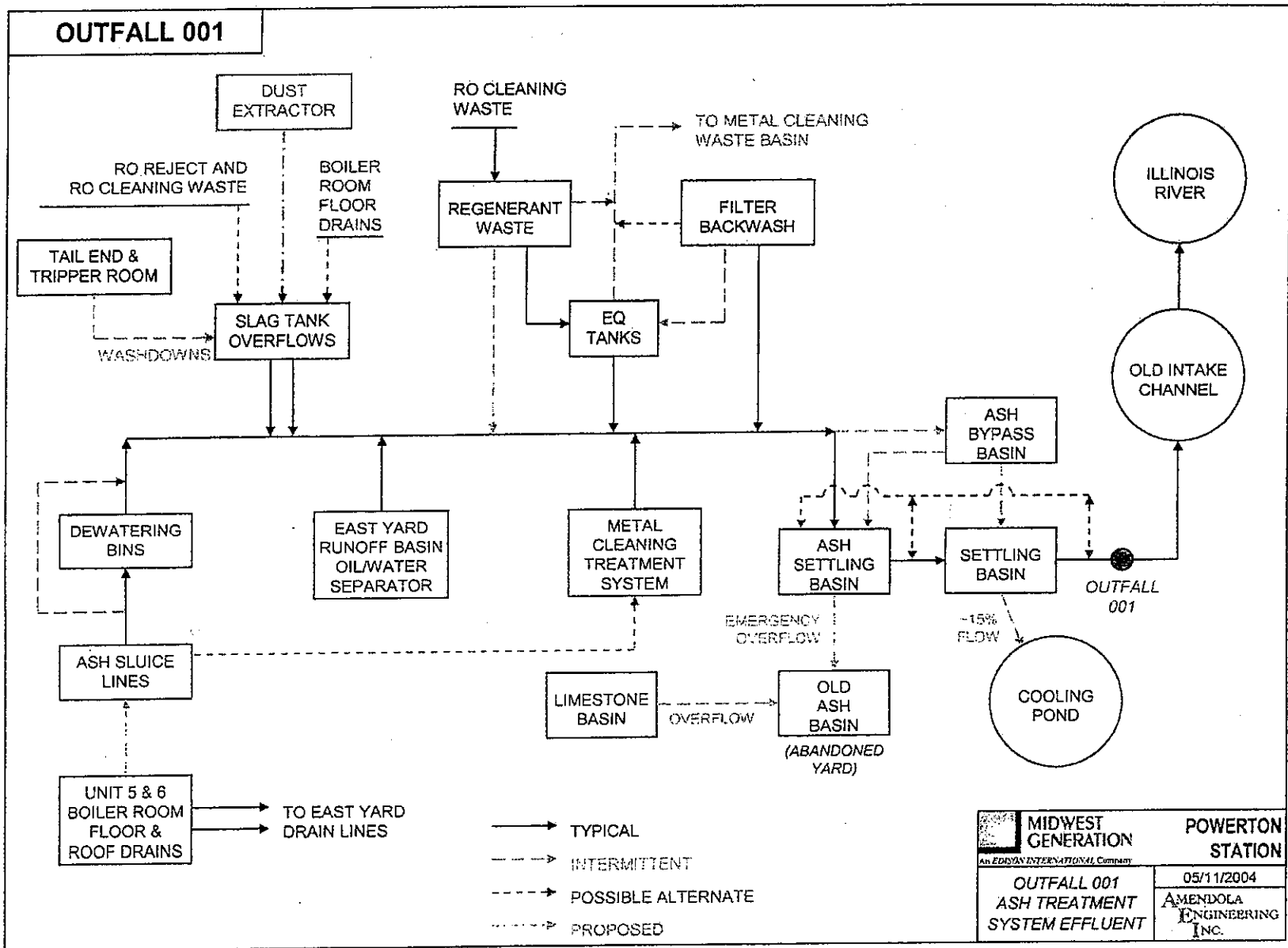

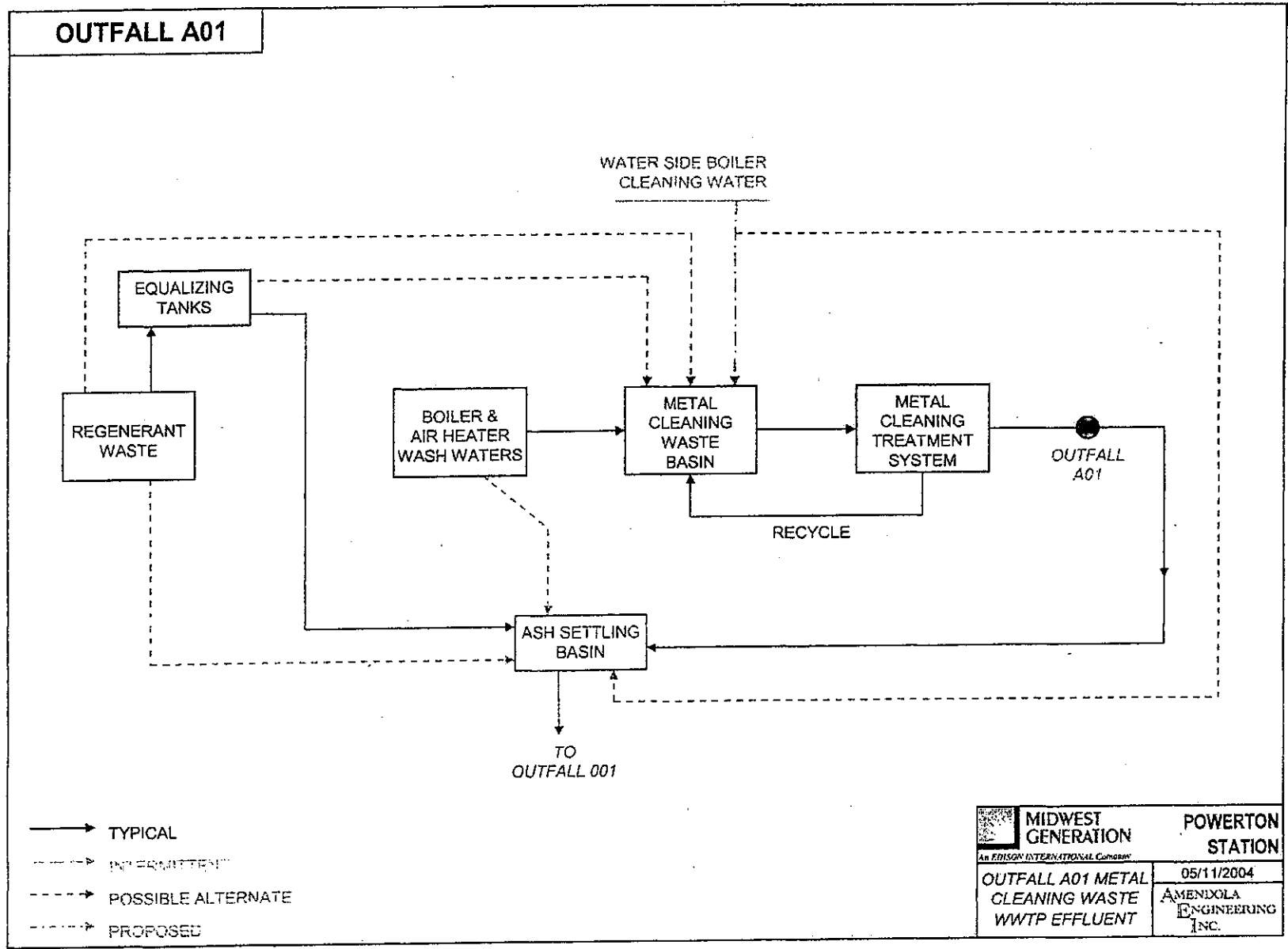

Environmental Protection Agency
State of Illinois

MARK S. KELLY

having fulfilled the requirements therefore, is hereby awarded this
Certificate of Competency
as an

Industrial
Wastewater Treatment Works Operator

COM. ED.
POWER TON.

Issued this 3rd day of AUGUST A.D. 1993

Thomas A. ...
Director

This Agency is authorized to require this information under Illinois Revised Statutes, 1979, Chapter 111 1/2, Section 1039. Disclosure of this information is required under that section. Failure to do so may prevent this form from being processed and could result in your application being denied.

For IEPA Use:

LOG #

DATE RECEIVED:

**ILLINOIS ENVIRONMENTAL PROTECTION AGENCY
DIVISION OF WATER POLLUTION CONTROL
PERMIT SECTION
Springfield, Illinois 62794-9276**

SCHEDULE N WASTE CHARACTERISTICS

1. Name of Project Powerton Secondary Ash Settling Basin Liner Replacement

2. FLOW DATA	EXISTING	PROPOSED-DESIGN
2.1	<u>13,130,000</u>	<u>21,600,000</u>
2.2 Maximum Daily Flow (gpd)	<u>32,400,000</u>	<u>32,400,000</u>

2.3 TEMPERATURE

Time of Year	Avg. Intake Temp. F	Avg. Effluent Temp. F	Max. Intake Temp. F	Max. Effluent Temp. F	Max. Temp. Outside Mixing Zone F
SUMMER	<u>NA</u>	<u>NA</u>	<u>NA</u>	<u>NA</u>	<u>NA</u>
WINTER	<u>NA</u>	<u>NA</u>	<u>NA</u>	<u>NA</u>	<u>NA</u>

2.4 Minimum 7-day, 10-year flow: NA cfs NA MGD.

2.5 Dilution Ratio: NA ;

2.6 Stream flow rate at time of sampling NA cfs NA MGD.

3. **CHEMICAL CONSTITUENT** Existing Permitted Conditions ; Existing conditions ; Proposed Permitted Conditions

Type of sample: grab (time of collection _____); composite (Number of samples per day NA)

(see instructions for analyses required)

CONSTITUENT	RAW WASTE (mg/l)	TREATED EFFLUENT Avg. (mg/l) Max.	UPSTREAM (mg/l)	DOWNSTREAM SAMPLES (mg/l)
Ammonia Nitrogen (as N)	NA	NA	NA	NA
Arsenic (total)	NA	NA	NA	NA
Barium	NA	NA	NA	NA
Boron	NA	NA	NA	NA
BOD ₅	NA	NA	NA	NA
Cadmium	NA	NA	NA	NA
Carbon Chloroform Extract	NA	NA	NA	NA
Chloride	NA	NA	NA	NA
Chromium (total hexavalent)	NA	NA	NA	NA
Chromium (total trivalent)	NA	NA	NA	NA

CONSTITUENT	RAW WASTE (mg/l)	TREATED EFFLUENT Avg. (mg/l) Max.	UPSTREAM (mg/l)	DOWNSTREAM SAMPLES (mg/l)
Copper	NA	NA	NA	NA
Cyanide (total)	NA	NA	NA	NA
Cyanide (readily released @ 150° F & pH 4.5)	NA	NA	NA	NA
Dissolved Oxygen	NA	NA	NA	NA
Fecal Coliform	NA	NA	NA	NA
Fluoride	NA	NA	NA	NA
Hardness (as Ca CO ₃)	NA	NA	NA	NA
Iron (total)	NA	NA	NA	NA
Lead	NA	NA	NA	NA
Manganese	NA	NA	NA	NA
MBAS	NA	NA	NA	NA
Mercury	NA	NA	NA	NA
Nickel	NA	NA	NA	NA
Nitrates (as N)	NA	NA	NA	NA
Oil & Grease (hexane solubles or equivalent)	NA	<6.0	NA	NA
Organic Nitrogen (as N)	NA	NA	NA	NA
pH	NA	7.4 / 7.9	NA	NA
Phenols	NA	NA	NA	NA
Phosphorous (as P)	NA	NA	NA	NA
Radioactivity	NA	NA	NA	NA
Selenium	NA	NA	NA	NA
Silver	NA	NA	NA	NA
Sulfate	NA	NA	NA	NA
Suspended Solids	NA	6.6	NA	6.6
Total Dissolved Solids	NA	NA	NA	NA
Zinc	NA	NA	NA	NA
Others				

APPENDIX B

APPENDIX B
PHOTOGRAPHS



Southwest end of basin looking north on October 20, 2009



Southwest end of basin looking east on October 20, 2009

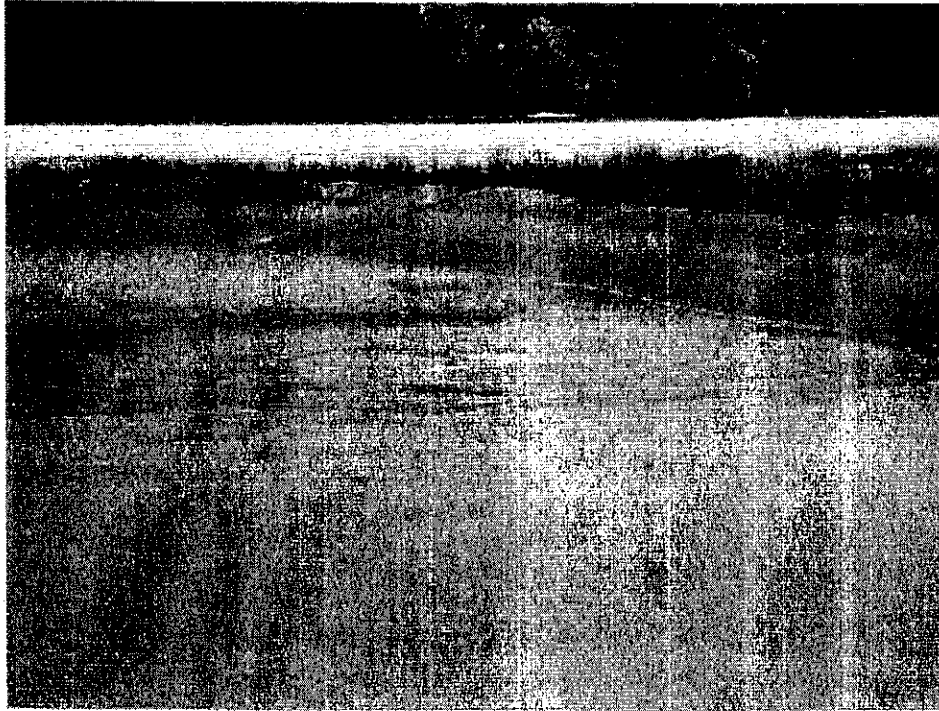

Looking northeast at basin near inlet area on October 20, 2009



Northeast corner of basin on October 20, 2009

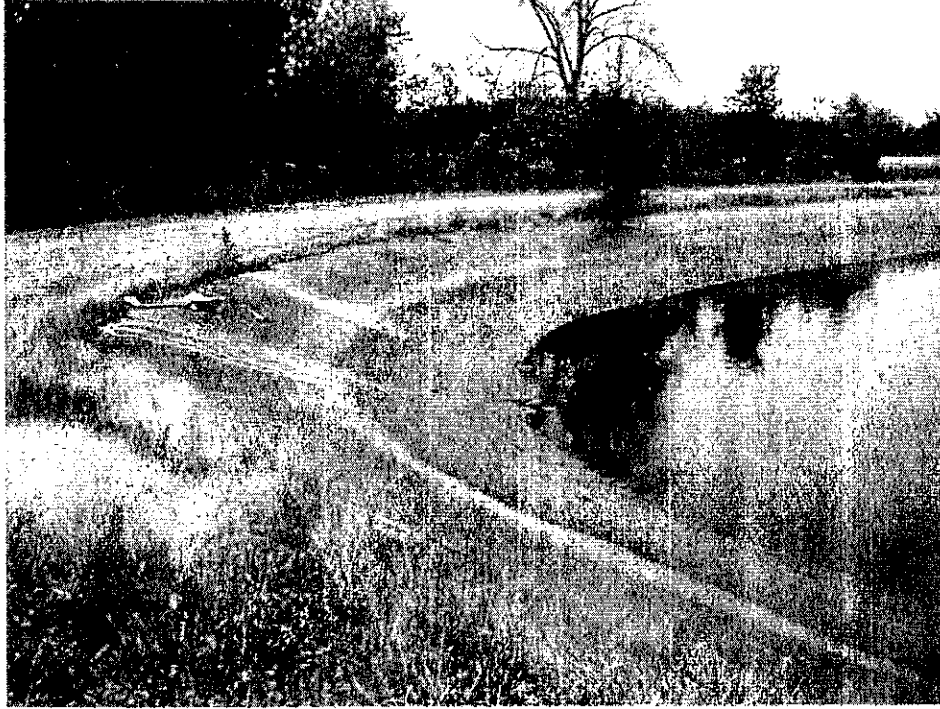

Southwest basin corner on October 20, 2009

APPENDIX C

APPENDIX C
SPECIFICATION SECTION 02600

SECTION 02600
HIGH DENSITY POLYETHYLENE (HDPE) GEOMEMBRANE

PART 1 - GENERAL

1.01 WORK INCLUDES

- A. Furnish all labor, materials, tools, supervision, transportation, and installation equipment necessary for installation of 60-mil High Density Polyethylene (HDPE) geomembrane, as specified herein, and as shown on Contract Drawings.

1.02 REFERENCE STANDARDS

- A. ASTM D6392 -Test Method for Determining the Integrity of Nonreinforced Geomembrane Seams Produced Using Thermo-Fusion Methods.
- B. ASTM D7007 Standard Practice for Locating Leaks in Geomembranes Covered with Water or Earthen Materials.
- C. GRI Test Method, GM 13 - Test Methods, Test Properties and Testing Frequency for High Density Polyethylene (HDPE) Smooth and Textured Geomembranes
- D. GRI Test Method, GM 14 - Selecting Variable Intervals for Taking Geomembrane Destructive Seam Samples Using the Method of Attributes.
- E. GRI Test Method, GM 19 - Seam Strength and Related Properties of Thermally Bonded Polyolefin Geomembranes.

1.03 DEFINITIONS

- A. Geomembrane Installer: hired by Contractor or Owner responsible for field handling, transporting, storing, deploying, seaming and testing of the geomembrane seams.
- B. Geomembrane Manufacturer: hired by Geomembrane Installer, Contractor, or Owner to provide HDPE geomembrane.
- C. Leak Location Contractor: hired by Contractor or Owner and responsible for locating potential holes in the installed geomembrane using electrical methods.
- D. Geosynthetic Quality Assurance Consultant: Consultant, independent from the Manufacturer, and Installer, responsible for field oversight of geosynthetics installation, and related testing, usually under the direction of the Owner.
- D. Geosynthetic Quality Assurance Laboratory (Testing Laboratory): Laboratory, independent from the Manufacturer and Installer, responsible for conducting laboratory tests on samples of geosynthetics obtained at the site or during manufacturing, usually under the direction of the Owner.

- D. Lot: A quantity of resin (usually the capacity of one rail car) used in the manufacture of geomembranes. Finished roll will be identified by a roll number traceable to the resin lot used.
- E. Resin Supplier: selected by Geomembrane Manufacturer to provide resin used in manufacturing geomembrane.
- F. Panel: Unit area of a geomembrane that will be seamed in the field that is larger than 100ft².
- G. Patch: Unit area of a geomembrane that will be seamed in the field that is less than 100ft².
- H. Subgrade Surface: Soil Layer surface which immediately underlies the geosynthetic material(s).

1.04 QUALITY ASSURANCE

- A. Qualifications:
 - 1. Geomembrane Manufacturer shall have a minimum of 5 years of continuous experience manufacturing HDPE geomembrane totaling 1,000,000 square feet.
 - 2. Geomembrane Installer:
 - a. 5 years of continuous experience in installation of HDPE geomembrane.
 - b. Experience totaling a minimum of 5,000,000 square feet of installed HDPE geomembrane on some combination of at least 10 completed facilities.
 - c. Personnel performing seaming operations qualified by experience or by successfully passing seaming tests. Master seamer shall have experience seaming a minimum of 3,000,000 square feet of geomembrane using same type of seaming apparatus to be used on this project.
 - 3. Leak Location Contractor:
 - d. 3 years of continuous experience in performing leak location surveys using electrical methods.
 - e. Experience totaling a minimum of 2,000,000 square feet of geomembrane leak location surveys on some combination of at least 5 completed facilities.
 - f. Personnel performing survey qualified by experience with at least 2 years of geomembrane testing experience using the leak location survey electrical method.
- B. Quality Assurance Program:

1. Geomembrane Manufacturer/Installer shall conform with requirements of these Technical Specifications.
2. The Owner or Contractor will engage and pay for the services of a Geosynthetic Quality Assurance Consultant and Laboratory to monitor geomembrane installation.

1.05 SUBMITTALS

- A. Prior to project start, submit the following to Geosynthetic Quality Assurance Consultant in accordance with Section 01300, Submittals:
 1. Raw Materials:
 - a. Name of Resin Supplier, location of supplier's production plant(s), resin brand name and product number.
 - b. Source and nature of plasticizers, fillers, carbon black and any other additives along with their percent addition to geomembrane material.
 - c. Test results documenting conformance with the "index properties" of GRI Test Method, GM 13.
 2. Geomembrane Manufacturer's Certification:
 - a. Written certification that Geomembrane Manufacturer's Quality Control Plan was fully implemented during production of geomembrane material supplied for this project. (Submittal shall be made within 5 working days of delivery to site).
 3. Geomembrane Installer's Seaming Personnel
 - a. Training completed by personnel.
 - b. Seaming experience for each personnel.
 4. Geomembrane Manufacturer Production Information:
 - a. Corporate background information indicating compliance with qualification requirements.
 - b. Quality control plan for manufacturing.
 - c. Copy of quality control certificates demonstrating compliance with the quality control plan for manufacturing and the test property requirements of GRI Test method, GM 13 (i.e. mill certificates).
 5. Geomembrane Installer's Information:

- a. Corporate background information indicating compliance with qualification requirements.
 - b. List of completed facilities, totaling 5,000,000 square feet minimum for which Geomembrane Installer has completed installation of a HDPE geomembrane. Include name and purpose of facility, location, date of installation, and quantity installed.
 - c. Resumes of personnel performing field seaming operation, along with pertinent experience information. Include documentation regarding which seamers are qualified to use thermal fusion welding apparatus.
 - d. Installation quality control plan.
6. Installation panel layout diagram identifying placement of geomembrane panels, seams, and any variance or additional details which deviate from Contract Drawings or Technical Specifications. Layout shall be drawn to scale and shall be adequate for use as a construction plan. Layout shall include dimensions and pertinent seam and anchorage details.
7. Installation Sequence and Schedule shall be included as part of Construction Progress Schedule.
8. Description of seaming apparatus to be used.
- B. With bid, submit the following to Owner and/or Engineer in accordance with Section 01300, Submittals
1. Leak Location Contractor's Work Plan:
 - a. Corporate background information indicating compliance with qualification requirements.
 - b. List of completed facilities, totaling 2,000,000 square feet minimum of geomembrane leak location surveys on some combination of at least 5 completed facilities. Include name and purpose of facility, location, date of survey, survey method, and quantity surveyed.
 - c. Resumes of personnel performing leak location survey, along with pertinent experience information.
 - d. Leak Location Contractor quality control plan including description of the proposed survey methods and procedures, and field calibration procedures.
 - e. Leak Location Contractor's required site preparations to be completed to perform the proposed leak location survey, and estimated duration to complete the survey.
 - f. An example of a final report (per ASTM D 7007) provided by the Leak Location Contractor following the completion of the survey.

- C. During installation, submit the following to the Geosynthetic Quality Assurance Consultant:
1. Daily records/logs prepared by Geomembrane Installer documenting work performed, personnel involved, general working conditions, and any problems encountered or anticipated on project. Submit on a weekly basis.
 2. Copy of subgrade acceptance signed by Geomembrane Installer for areas to be covered with geomembrane each day.
- D. Within 10 days of geomembrane installation completion, submit the following to Geosynthetic Quality Assurance Consultant:
1. Geomembrane installation certification that Work was performed under Geomembrane Installer's approved quality control plan and in substantial compliance with Technical Specifications and Contract Drawings.
 2. As-built panel diagram identifying placement of geomembrane panels, seams, repairs, and destructive seam sample locations.
 3. Copy of warranty for material (including factory seams) and installation covering both for a period of 2 years from the date of substantial completion.
- E. The Geosynthetic Quality Assurance Consultant will review and inspect HDPE geomembrane installation upon completion of all Work specified in this Section. Deficiencies noted shall be corrected at no additional cost to the Owner.
- F. The Geosynthetic Quality Assurance Consultant will provide written final acceptance of the geomembrane installation after completion of material placement above geomembrane. Written conditional geomembrane installation acceptance can be provided to the Contractor prior to completion of material placement above geomembrane when the following conditions are satisfied, if necessary, and requested by the Contractor:
1. The entire geomembrane installation is completed or any pre-determined subsection if the project is phased.
 2. All installation quality assurance/control documentation has been completed and submitted to the Geosynthetic Quality Assurance Consultant or Owner.
 3. Verification of the adequacy of all field seams, repairs and associated testing is complete.

1.06 DELIVERY, STORAGE, AND HANDLING

- A. Transportation:
1. Geomembrane rolls shall be transported, unloaded and handled at the job site in accordance with manufacturer recommendations. Damaged material may be rejected by the Geosynthetic Quality Assurance Consultant.

B. On-site Storage:

1. Geomembrane rolls which have been delivered to job site shall be unloaded and stored in original, unopened packaging in a secure location, determined by Owner and/or Geosynthetic Quality Assurance Consultant.
2. Store geomembrane rolls to ensure adequate protection against exposure to the following:
 - a. Equipment;
 - b. Strong oxidizing chemicals, acids, or bases;
 - c. Flames, including welding sparks;
 - d. Temperatures in excess of 160 deg. F;
 - e. Dust;
 - f. Ultraviolet radiation (i.e. sunlight); and
 - g. Inclement weather.
3. Whenever possible, provide a 6-inch minimum air space between rolls.
4. Containers/rolls shall not be stacked.

C. On-Site Handling:

1. Handle rolls per Geomembrane Manufacturer's recommendations and as necessary to prevent damage.

PART 2 - PRODUCTS

2.01 MATERIALS

A. High Density Polyethylene (HDPE) White Textured Geomembrane.

1. HDPE geomembrane shall be white, textured, 60-mil product approved by the Engineer and/or Geosynthetic Quality Assurance Consultant.
2. The Contractor shall submit, with the bid, written certification from the proposed Geomembrane Manufacturer that geomembrane products proposed in the bid satisfy the following requirements:
 - a. The proposed HDPE compound shall be comprised entirely of virgin materials. Compliance with this specification shall be documented in accordance with Geomembrane Manufacturer's quality control program and submitted to the Geosynthetic Quality Assurance Consultant with the written conformance certification.

- b. The proposed Geomembrane Manufacturer shall certify that any plasticizers, fillers and additives incorporated into the manufacturing process for the proposed HDPE geomembrane have demonstrated acceptable performance on past projects.
 - c. The proposed geomembrane shall meet the requirements of Geosynthetic Research Institute's test method GM 13.
 - d. The nominal thickness of proposed geomembrane shall be 60 mil., or as approved by the Engineer and/or Geosynthetic Quality Assurance Consultant.
3. Geomembrane sheets shall be visually consistent in appearance and shall contain no holes, blisters, undisbursed raw materials or other signs of contamination by foreign material. Geomembrane must have no striations, roughness or bubbles on the surface.
- B. Seaming Apparatus
- 1. Thermal fusion welding machines used for joining geomembrane surfaces may be either extrusion or hot wedge. These machines shall include sufficient temperature and rate-of-travel monitoring devices to allow continuous monitoring of operating conditions.
 - 2. One spare, operable thermal fusion seaming device shall be maintained on site at all times.
- C. Field Test Equipment
- 1. Field Tensiometer: the field tensiometer shall be calibrated within three months prior to project start date over the range of field test values.
 - 2. Air Channel Test Equipment: air channel test equipment shall consist of hoses, fittings, valves and pressure gauge(s) needed to deliver and monitor the pressure of compressed air through an approved pressure feed device.
 - 3. Air Compressor: the air compressor utilized for field testing shall be capable of producing and maintaining an operating pressure of at least 50 psi.
 - 4. Vacuum Box: the vacuum box shall consist of a vacuum gage, valve, and a gasket around the edge of the open bottom needed to apply vacuum to a surface.

2.02. CONFORMANCE TESTING REQUIREMENTS

- A. Geomembrane shipped to site shall undergo conformance testing. Manufacturer's roll certificates may be used for conformance evaluation at the option of the Geosynthetic Assurance Consultant. Nonconforming material shall either be retested at the direction of the Geosynthetic Quality Assurance Consultant or removed from site and replaced at Contractor's expense.

B. Conformance Test Methods

1. Samples will be located and collected by the Geosynthetic Quality Assurance Consultant at a rate of one sample per 100,000 square feet of geomembrane delivered to site.
2. One sample will be obtained from each geomembrane production batch delivered to the site.
3. Samples shall be cut by Geomembrane Installer and be at least 45 square feet in size.
4. Samples shall be tested in accordance with Table 1 (Smooth) or Table 2 (Textured) specified in GRI Test Method GM13.
5. Geomembrane thickness shall be measured a minimum of three times per panel during deployment to verify conformance with GRI Test Method GM13.

C. Role of Testing Laboratories

1. The Geosynthetic Quality Assurance Consultant will be responsible for acquiring samples of the geomembrane for conformance testing. The Owner or Geosynthetic Quality Assurance Consultant will retain an independent, third party laboratory to perform conformance testing on samples of geomembrane.
2. Retesting of geomembrane panels by the Geomembrane Installer because of failure to meet any of the conformance specifications can only be authorized by the Geosynthetic Quality Assurance Consultant. Non-conforming panels may be retested in accordance with Subsection 2.02(B) and 2.02(D) under authorization of the Geosynthetic Quality Assurance Consultant only.
3. The Geomembrane Manufacturer and/or Geomembrane Installer may perform independent tests in accordance with methods and procedures specified in Subsection 2.02(B). Results shall not be substituted for quality assurance testing described herein.

D. Procedures for Determining Conformance Test Failures

1. If conformance test results fail to meet specifications, the roll and/or batch may be retested using specimens from either the original roll sample or from another sample collected by the Geosynthetic Quality Assurance Consultant. Two additional tests (retests) shall be performed for each failed test procedure. Each retest shall consist of multiple specimen tests if multiple specimens are specified in the test procedure. If the results of both retests meet specifications, the roll and batch will be considered to have passed conformance testing.

2. Failure of any retest shall be cause for rejection of the entire roll or batch depending on the type of failing test. The Geosynthetic Quality Assurance Consultant reserves the right to collect samples from other rolls of a particular batch for further conformance testing. The Geosynthetic Quality Assurance Consultant may choose to accept only a portion of the batch on the basis of the results of conformance testing of samples collected from other rolls.
3. If retesting does not result in conformance with the specifications as defined in preceding paragraph, or if there are any other nonconformities with the material specifications, the Contractor shall remove the rolls from use in the project. The Contractor shall also be responsible for removal of rejected geomembrane from the site and replacement with acceptable geomembrane at no additional cost to the Owner.

PART 3 - EXECUTION

3.01 PRE-CONSTRUCTION MEETING

- A. A Pre-Construction Meeting shall be held at the site to discuss and plan the details of geomembrane installation. This meeting shall be attended by the Geomembrane Installer, Owner, Engineer and the Contractor.
- B. The following topics relating to geomembrane installation shall be addressed:
 1. Responsibilities of each party.
 2. Lines of authority and communication.
 3. Methods for documenting, reporting and distributing documents and reports.
 4. Procedures for packaging and storing archive samples.
 5. Review of the schedule for all installation and quality assurance testing, including third-party testing turnaround times.
 6. Review of panel layout, access and numbering systems for panels and seams including details for marking on the HDPE geomembrane.
 7. Procedures and responsibilities for preparation and submittal of as-built drawings.
 8. Temperature and weather limitations, installation procedures for adverse weather conditions and defining acceptable subgrade or ambient moisture and temperature conditions for working during liner installation.
 9. Subgrade conditions, dewatering responsibilities and subgrade maintenance plan.
 10. Deployment techniques including allowable subgrade for geomembrane.
 11. Procedures for covering of the geomembrane to prevent damage.

12. Plan for minimizing wrinkles in the geomembrane.
13. Measurement and payment schedules.
14. Site health and safety procedures/protocols.

3.02 SUBGRADE PREPARATION

- A. Contractor shall prepare a subgrade surface in accordance with Section 02300, Earthwork.
- B. The Contractor shall not excavate more than the amount of anchor trench required for one day of geosynthetics deployment, unless otherwise specified by the Geosynthetic Quality Assurance Consultant. Rounded corners shall be provided in the trenches where the geosynthetics enter the trench to allow them to be uniformly supported by the subgrade and to avoid sharp bends. The geosynthetics shall not be supported by loose soils in anchor trenches.
- C. The Geomembrane Installer shall visually inspect the subgrade immediately prior to geomembrane deployment. Inspection shall verify that there are no potentially harmful foreign objects present, such as sharp rocks and other deleterious debris. Any foreign objects encountered shall be removed by Geomembrane Installer or Contractor. All subgrade damaged by construction equipment and deemed unsuitable for geomembrane deployment shall be repaired prior to geomembrane deployment. All repairs shall be approved by the Geosynthetic Quality Assurance Consultant and Geomembrane Installer. The responsibility for preparation, repairs, and maintenance of the subgrade shall be defined in the preconstruction meeting. The Geomembrane Installer shall provide the Geosynthetic Quality Assurance Consultant with written acceptance of subgrade surface over which geomembrane is deployed (Part 1.05C) for each day of deployment.

3.03 GEOMEMBRANE DEPLOYMENT

- A. Geomembrane shall not be deployed until all applicable certifications/quality control certificates listed in Subsection 1.05 of this section and conformance testing listed in Subsection 2.02 of this section are submitted and approved by the Geosynthetic Quality Assurance Consultant. Any geomembrane deployed prior to approval by the Geosynthetic Quality Assurance Consultant shall be at the sole risk of the Geomembrane Installer and/or Contractor. If material installed prior to approval by the Geosynthetic Quality Assurance Consultant does not meet the requirements of this specification, it shall be removed from the site at no additional cost to the Owner.
- B. Geomembrane will be deployed according to submitted panel layout drawing as approved by the Geosynthetic Quality Assurance Consultant. The Geosynthetic Quality Assurance Consultant is to be notified of and approve any revisions or modifications to the approved panel layout drawing prior to deploying geomembrane in the area of review.
- C. Adequate temporary anchoring (sand bags, tires, etc.) that will not damage the geomembrane shall be placed on a deployed panel to prevent uplift by wind.
- D. Geomembrane shall not be deployed if:

1. Ambient temperatures are below 41 degrees F (5 degrees C) or above 104 degrees F (40 degrees C) measured six inches above geomembrane surface unless approved by the Geosynthetic Quality Assurance Consultant.
 2. Precipitation is expected or in the presence of excessive moisture or ponded water on the subgrade surface.
 3. Winds are excessive as determined by Geomembrane Installer in agreement with the Geosynthetic Quality Assurance Consultant.
 4. The Geosynthetic Quality Assurance Consultant will have the authority to suspend work during such conditions.
- E. The Geomembrane Installer shall be responsible for conformance with the following requirements:
1. Equipment utilized for installation/quality assurance testing does not damage geomembrane. Such equipment shall have rubber tires and a ground pressure not exceeding 5 psi or total weight exceeding 750 lbs. Only equipment necessary for installation and quality assurance testing is allowed on the deployed geomembrane.
 2. Personnel working on geomembrane do not damage geomembrane (activities such as smoking or wearing damaging clothing shall not be allowed).
 3. Method of deployment does not damage geomembrane.
 4. Method of deployment minimizes wrinkles.
 5. Temporary loading or anchoring does not damage geomembrane.
 6. Direct contact with geomembrane is minimized.
- F. No vehicles shall be allowed on deployed geomembrane under any circumstances.

3.04 FIELD SEAMS

- A. Seam Layout
1. In general, seams shall be oriented parallel to the line of the maximum slope. In corners and at other odd-shaped geometric intersections, number of seams should be minimized. If at all possible, seams shall not be located at low points in the subgrade unless geometry requires seaming to be done at these locations.
 2. A seam numbering system compatible with the panel numbering system shall be agreed upon at the Pre-Construction Meeting.

B. Seaming Processes/Equipment

1. Approved processes for field seaming (panel to panel) are extrusion or hot wedge fusion-type seam methods. No other processes can be used without prior written authorization from the Geosynthetic Quality Assurance Consultant. Only equipment which has been specifically approved by make and model shall be used, if applicable.
4. The Geomembrane Installer will meet the following requirements regarding use, availability, and cleaning of welding equipment at job site:
 - a. Intersecting hot wedge seams shall be patched using extrusion welding process.
 - b. Electric generator for equipment shall be placed on a smooth base such that no damage occurs to geomembrane. A smooth insulating plate or fabric shall be placed beneath hot equipment after usage.
3. The Geomembrane Installer shall keep records for performance and testing of all seams.

C. Seaming Requirements/Procedures

1. Weather Conditions - Range of weather conditions under which geomembrane seaming can be performed are as follows:
 - a. Unless otherwise authorized in writing by Geosynthetic Quality Assurance Consultant, no seaming shall be attempted or performed at an ambient temperature below 41 degrees F (5 degrees C) or above 104 degrees F (40 degrees C).
 - b. Between ambient temperatures of 32 degrees F (0 degrees C) and 41 degrees F (5 degrees C), seaming shall be performed only if geomembrane is preheated by either sun or a hot air device, provided there is no excessive ambient cooling resulting from high winds. Pre-qualification seams shall be produced under identical conditions.
 - c. Above 41 degrees F (5 degrees C), no preheating of geomembrane will be required.
 - d. Geomembrane shall be dry and protected from wind.
 - e. Seaming shall not be performed during any precipitation event.
 - f. Seaming shall not be performed in areas where ponded water has collected below surface of geomembrane.
2. If the Geomembrane Installer chooses to use methods which may allow seaming at ambient temperatures below 41 degrees F or above 104 degrees F, the Geomembrane Installer shall demonstrate and submit certification to

Geosynthetic Quality Assurance Consultant that methods and techniques used to perform seaming produce seams that are equivalent to seams produced at temperatures above 41 degrees F and below 104 degrees F. The Geosynthetic Quality Assurance Consultant may deny approval for use of the proposed technique regardless of demonstration results.

3. Overlapping - Geomembrane panels shall have finished overlap as follows:
 - a. Minimum of 6 inches for thermal fusion welding.
 - b. Insufficient overlap will be considered a failed seam.
4. Pre-qualification tests for geomembrane fusion welding shall be conducted by a minimum of 2 pre-qualification seams conducted per day per welding machine by each seaming technician performing welding with that machine. At least one test shall be performed at the start of each work day, with tests at intervals of no greater than 5 hours and additional pre-qualification tests following work interruptions, weather changes, changes to machine settings, or as directed by the Geosynthetic Quality Assurance Consultant. Pre-qualification seams shall be made under the same conditions as the actual seams.
 - a. Pre-qualification seam samples shall be 5 feet long by 1-foot wide (minimum) after seaming, with seam centered along its length. Each pre-qualification seam shall be labeled with the date, geomembrane temperature, seaming unit identifier, seam number or test location, technician performing the test seam and description of testing results.
 - b. Seam overlap shall be in accordance with Subsection 3.04(C)(3).
 - c. Pre-qualification seams shall be inspected for proper squeeze-out, footprint pressure, and general appearance.
 - d. Four specimens, each 1-inch in length, shall be cut from opposite ends of the pre-qualification seam sample by the Geomembrane Installer. The remainder of pre-qualification seam shall be retained by the Geosynthetic Quality Assurance Consultant and may be submitted for laboratory testing.
 - e. The Geomembrane Installer shall complete two shear tests and two peel tests in accordance with GRI GM 19.
 - f. Pre-qualification seams failed by inspection or testing may be retested at request of the Geomembrane Installer. If the second pre-qualification seam fails, then the seaming apparatus or seaming technique shall be disqualified from use until two consecutive, satisfactory pre-qualification seams are obtained.
5. Seam Preparation
 - a. Prior to seaming, seam area shall be clean and free of moisture, dust, dirt, debris of any kind, and foreign material.

- b. Seams shall be aligned so as to minimize number of wrinkles and fishmouths.
- 6. General Seaming Procedures
 - a. Fishmouths or wrinkles at seam overlaps shall be cut along ridge of the wrinkle to achieve a flat overlap. Cut fishmouths or wrinkles shall be repaired, and/or patched in accordance with Part 3.08.
 - b. Seaming shall extend to the outside edge of geomembrane panels including material placed in anchor trenches.
 - c. The intersecting thermal fusion seams shall be patched using the extrusion welding process.

3.05 NON-DESTRUCTIVE TESTING

- A. Each field seam shall be non-destructively tested over its entire length by the Installer. Testing shall be conducted as field seaming progresses, not at completion of all seams, unless specifically agreed to by the Geosynthetic Quality Assurance Consultant in writing.
- B. Vacuum Testing – shall be performed in accordance with ASTM D5641, Standard Practice for Geomembrane Seam Evaluation by Vacuum Chamber.
- C. Air Pressure Testing – shall be performed in accordance with ASTM D5820, Standard Practice for Pressurized Air Channel Evaluation of Dual Seamed Geomembranes, and GRI GM 6, Pressurized Air Channel Test for Dual Seamed Geomembranes.
- D. Each seam tested non-destructively shall be marked with the date of the test, name of the testing technician, length of the seam, test method and results. The same shall also be recorded by the Geosynthetic Quality Assurance Consultant on the appropriate CQA documentation.
- E. Non-Destructive Seam Test Failures
 - 1. Seams failing non-destructive testing shall be repaired by the Geomembrane Installer according to Part 3.08. Seams shall be non-destructively retested. If the seam defect cannot be located, the entire section of seam affected shall be repaired and retested.

3.06 DESTRUCTIVE TESTING

- A. The Owner shall have the option to destructively test geomembrane panel seams completed in the field. Destructive seam testing shall be performed by the Geomembrane Installer under the observation of the Geosynthetic Quality Assurance Consultant.

B. Sampling Procedure

1. For each sample location, the Geosynthetic Installer will:
 - a. Assign a sample number and mark the sample accordingly.
 - b. Record the sample location on the as-built layout drawing.
 - c. By sample number, record reason for collecting sample (e.g., as part of statistical testing program, suspicious seam, retest, etc.).
 - d. Record pertinent information, including date, time, seam number, number of seaming unit, and name of seamer, on the seam sample.
2. Each destructive sample shall be at least 12 inches wide (at least 6 inches on each side of seam) by 54 inches long. Samples will be cut by the Geomembrane Installer and distributed as follows:
 - a. A 12-inch by 12-inch portion shall be cut and tested in accordance with Subsection 3.06(C) by the Geomembrane Installer.
 - b. A 12-inch by 12-inch portion shall be cut and retained by the Geomembrane Installer. The Geomembrane Installer may elect to omit this requirement.
 - c. A 12-inch by 12-inch portion shall be cut and retained by the Geosynthetic Quality Assurance Consultant as an archive sample.
 - d. A 12-inch by 18-inch portion shall be submitted by the Geosynthetic Quality Assurance Consultant for laboratory testing as described in Part 3.06(D).
3. Ten specimens, each 1 inch wide by 12 inches long with seam centered perpendicular to width, shall be collected and field tested by the Geomembrane Installer prior to shipping the sample to the laboratory. If all samples pass field tensiometer test described in Part 3.06(C), then the laboratory sample shall be submitted for testing by the Geosynthetic Quality Assurance Consultant.
4. Holes cut into geomembrane resulting from destructive seam sampling shall be immediately repaired by Geomembrane Installer in accordance with repair procedures described in Part 3.08.

C. Field Test Methods

1. Ten 1-inch-wide samples described above under Part 3.06(B)(3) shall be field tested for peel (5 samples) and shear (5 samples) in accordance with GRI GM 19.
2. One seam sample shall be field tested for peel and shear at the end of each continuous field seam 100 feet or greater in length.
3. Testing shall be performed in accordance with ASTM D6392 using a field tensiometer or equivalent device to qualitatively and quantitatively determine mode of failure.
4. Seam shall be considered passing if failure in both peel and shear meet criteria listed in GRI GM 19.
5. The procedures specified in Subsection 3.06(D) shall be implemented when sample passes field tensiometer test.

D. Laboratory Test Methods

1. Laboratory testing of seam samples shall be conducted by the Geosynthetic Quality Assurance Laboratory under contract with the Geosynthetic Quality Assurance Consultant or Owner. Five specimens shall be tested in shear and five in peel.
2. Laboratory testing shall be conducted in accordance with GRI GM 19.
3. For both seam shear and peel tension tests, an indication will be given for each specimen tested which defines locus of failure.
4. For shear tests, the following values, along with the mean and standard deviation where appropriate, will be reported for each specimen tested:
 - a. Maximum tension in pounds per square inch.
 - b. Elongation at break (up to a tested maximum of 100 percent).
 - c. Locus of failure using ASTM D6392 designations.
5. For peel tests, the following values, along with the mean and standard deviation where appropriate, will be reported for each specimen tested:
 - a. Maximum tension in pounds per square inch.
 - b. Seam separation (expressed as percent of original seam area).

- c. Locus of failure.
 6. Retesting of seams due to nonconformance with specifications may be performed at the discretion of the Geosynthetic Quality Assurance Consultant.
- E. Destructive Seam Test Failure
 1. Shear and peel test results derived from testing described in Parts 3.06(C) and 3.06(D) shall comply with GRI GM 19 for seam to be considered acceptable.
 2. The Geomembrane Installer has two options in determining the repair boundary whenever a seam has failed destructive testing:
 - a. The seam can be reconstructed between the two previously tested and passed destructive sample locations; or,
 - b. The Geomembrane Installer can trace the welding path to an intermediate location at least ten feet from point of failed test in each direction and obtain destructive test samples collected from these locations. If destructive tests on these samples are acceptable, then the seam shall be reconstructed between the intermediate locations. If either sample fails, the process may be repeated until an acceptable seam test has been performed on both sides of the original failed sample. If a passing sample is not realized on one (or both) side of the original failed sample, then seam repair must extend to the end(s) of the seam. Retesting of seams according to this procedure shall utilize the sampling methodology described in Part 3.06(B). The Owner reserves the right to terminate this process, at the discretion of the Geosynthetic Quality Assurance Consultant, after the second retesting. An additional sample taken from the reconstructed zone must pass destructive seam testing if destructive sample failure(s) causes reconstruction.
 3. The Geosynthetic Quality Assurance Consultant shall be responsible for documenting all actions taken in repairing seams. The Geomembrane Installer will be responsible for keeping the Geosynthetic Quality Assurance Consultant informed of seaming progress.
 4. Additional fees for destructive seam test failures shall be assessed to the Contractor and deducted from payment. This fee shall be assessed only if the failing sample is a laboratory sample.

3.07 ELECTRONIC LEAK LOCATION SURVEY

- A. The Owner shall have the option to conduct an electronic leak location survey. Leak location survey shall be performed by the Leak Location Contractor under the observation of the Geosynthetic Quality Assurance Consultant.
- B. Leak Location Contractor shall identify actions required by Contractor to prepare the site for the leak location survey.
- C. Contractor shall ensure that the layers above and below the geomembrane contains sufficient moisture to conduct a leak location survey. Typically, a moisture content of earth materials of 1% to 2% by weight is sufficient to conduct the survey. If the moisture content of layers above and/or below the geomembrane is not sufficient per the requirements of the Leak Location Contractor, Contractor shall add moisture to the layers, as required.
- D. Contractor shall provide electrical isolation of the metal marker posts, batten bars, and concrete structures, as requested by Leak Location Contractor.
- E. Leak Location Contractor shall inspect the site prior to commencing the survey to ensure all site preparations are completed and the site conditions are appropriate for conducting the leak location survey.
- F. Any discrepancy in the required site preparation detailed in the Leak Location Contractor's Work Plan or site conditions shall be reported to the Contractor for corrective or appropriate action.
- G. After the final layer is placed above the geomembrane, conduct a leak location survey on the final layer material using the procedures for surveys with earth materials covering the Geomembrane as described in ASTM D 7007.
- H. A leak detection sensitivity test using an artificial leak shall be conducted on the geomembrane for each set of equipment used before the equipment is used on for the leak location survey, as described in ASTM D 7007 to determine the detection distance for the survey.
- I. The leak location survey shall be taken on survey lines or on a grid spaced no farther apart than twice the leak detection distance as determined in the leak detection sensitivity test.
- J. The Leak Location Contractor shall inform the Owner and/or Engineer and mark the locations of all identified or indicated leaks with a flag or spray paint. The Geomembrane Installer shall repair the defect/hole as detailed in Part 3.08 of this Section.

3.08 DEFECTS AND REPAIRS

- A. The geomembrane shall be examined by the Geomembrane Installer and the Engineer for defects, holes, blisters, undispersed raw materials, and any signs of contamination by foreign matter. The geomembrane surface shall be swept and/or washed by the Geomembrane Installer if the amount of dust or mud inhibits examination. The

Contractor shall provide a water truck, an operator, clean water and hoses as reasonably necessary to assist the Geomembrane Installer in this activity.

- B. Portions of geomembrane exhibiting flaws, or failing a non-destructive or destructive (if conducted) test, shall be repaired or replaced by the Geomembrane Installer. Repair procedures available include:
1. Patching - used to repair large holes, tears, undispersed raw materials, contamination by foreign matter, holes resulting from destructive sampling (if conducted), and locations where seam overlap is insufficient;
 2. Capping - used to repair large lengths of failed seams; and
 3. Additional Procedures - used upon recommendation of the Geomembrane Installer if agreed to by the Engineer.
- C. Patches or caps.
1. Extend patch or cap 6 inches (minimum) beyond the edge of the defect.
 2. Round corners of patch and/or cap (suggest 3-inch radius).
 3. Repair procedures, equipment, materials, and techniques will be approved by the Geosynthetic Quality Assurance Consultant prior to repair.
 4. Geomembrane below large caps shall be appropriately cut to avoid water or gas collection between two sheets.
- D. The Geomembrane Installer shall mark on the geomembrane (using a non-puncturing writing utensil), repair date, time, and personnel involved.
- E. Each repair shall be non-destructively tested in accordance with Part 3.05. Large caps may require destructive test sampling in accordance with Part 3.06 at the discretion of the Geosynthetic Quality Assurance Consultant.
- F. Repairs which fail testing shall be redone and retested until a passing result is obtained. The Geomembrane Installer will perform non-destructive testing on repairs and will document retesting of repairs.
- G. The Geosynthetic Quality Assurance Consultant will document repairs, repair testing, and retesting results.
- H. The Geomembrane Installer shall cut and seam wrinkles which may adversely affect long-term integrity of the geomembrane, hinder subsequent construction of overlying layers, or impede drainage off of the geomembrane after it is covered by soil. Seaming shall be done in accordance with procedures described in Parts 3.04(B) and 3.04(C), and it shall be subject to test provisions of Parts 3.05 (non-destructive testing) and 3.06 (destructive testing – if conducted).

3.09 PROTRUSIONS AND CONNECTIONS TO GEOMEMBRANE

- A. If required, the Geomembrane Installer shall install geomembrane around utility poles, guy wires, and other structures according to the Contract Drawings and the following requirements:
 - 1. Use minimum 1-ft long geomembrane pipe boots and steel clamps to seal the geomembrane around pole or structure.
 - 2. Use standard welding procedures to seam the geomembrane boot to the geomembrane.
 - 3. Seaming performed on and around penetrations, and other appurtenances shall be non-destructively tested using the vacuum testing method.

3.10 SURVEY DOCUMENTATION

- A. The Geomembrane Installer shall survey the completed geomembrane prior to covering and provide the Geosynthetic Quality Assurance Consultant with 24-hour notification of survey. The Contractor shall document the location of all seams (panel corners acceptable), destructive test samples (if conducted) and repairs. The Contractor shall provide survey data to the Geosynthetic Quality Assurance Consultant within two working day of survey completion.

3.11 DAILY FIELD INSTALLATION REPORTS

- A. At the beginning of each day, the Geomembrane Installer shall provide the Geosynthetic Quality Assurance Consultant with a report for all work completed the previous day.
- B. The Daily Field Installation Report shall include the following:
 - 1. The total amount and location of geomembrane placed.
 - 2. The total length and location of seams completed, technician name and welding unit numbers.
 - 3. A drawing or sketch depicting the geomembrane installed the previous day including the panel number, seam number and locations of non-destructive and destructive testing (if conducted).
 - 4. Results of pre-qualification test seams, if available.
 - 5. Results of non-destructive testing.
- C. Destructive test results (if conducted) shall be reported within 48 hours or prior to covering the geomembrane, whichever is practical.

3.12 MATERIAL ABOVE GEOMEMBRANE

- A. The Geosynthetic Quality Assurance Consultant and Geomembrane Installer shall verify the area of geomembrane completion prior to placement of material over the geomembrane.
- B. Soils - Apply following general criteria for covering of the geomembrane:
 - 1. Do not place soils on the geomembrane at an ambient temperature below 32 degrees F, (0 degrees C) nor above 104 degrees F (40 degrees C), unless otherwise specified.
 - 2. Do not drive equipment used for placing soil directly on the geomembrane.
 - 3. A minimum thickness of 1 foot of soil is specified between a low ground pressure dozer (maximum contact pressure of 5 lb/sq. inch) and the geomembrane.
 - 4. A minimum thickness of 2 feet of soil is required between rubber-tired vehicles and the geomembrane.
 - 5. Do not compact soils placed directly on geomembrane.
 - 6. Damage to the geomembrane resulting from placement of cover soils shall be repaired in accordance with Part 3.08 by the Geomembrane Installer at the Contractor's expense.
 - 7. Do not push soil downslope. Soil shall be placed over the geomembrane starting from base of the slope, up to top of the slope.

END OF SECTION

SHEETS

SHEETS

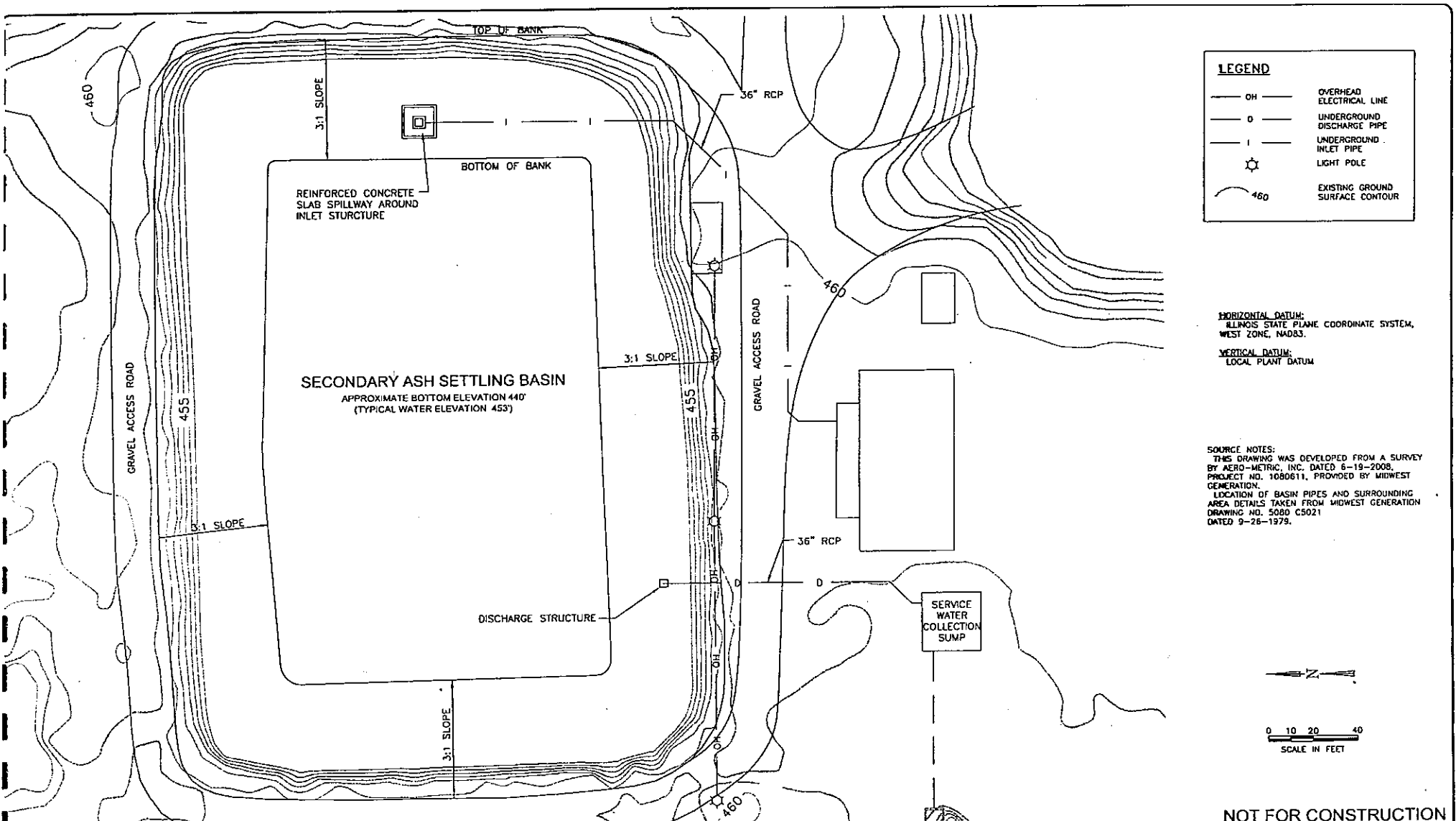

LEGEND	
— OH —	OVERHEAD ELECTRICAL LINE
— D —	UNDERGROUND DISCHARGE PIPE
— I —	UNDERGROUND INLET PIPE
⊙	LIGHT POLE
⤴ 460	EXISTING GROUND SURFACE CONTOUR

HORIZONTAL DATUM:
ILLINOIS STATE PLANE COORDINATE SYSTEM,
WEST ZONE, NAD83.

VERTICAL DATUM:
LOCAL PLANT DATUM

SOURCE NOTES:
THIS DRAWING WAS DEVELOPED FROM A SURVEY
BY AERO-METRIC, INC. DATED 6-19-2008,
PROJECT NO. 1080611, PROVIDED BY MIDWEST
GENERATION.
LOCATION OF BASIN PIPES AND SURROUNDING
AREA DETAILS TAKEN FROM MIDWEST GENERATION
DRAWING NO. 5080 CS021
DATED 9-26-1979.

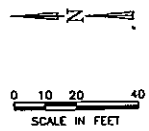

NOT FOR CONSTRUCTION

6			
5			
4			
3			
2			
1			
C	ISSUED FOR PERMIT	HMS	12/22/09
REVISION:		DATE:	APP'D BY:



PROJECT NO. 1965/3.2	EXISTING CONDITIONS SECONDARY ASH SETTLING BASIN REPLACEMENT MIDWEST GENERATION POWERTON POWER STATION PEKIN, ILLINOIS	SHEET NO. CD10
DRAWN BY: KMF 11/18/08		
CHECKED BY: RUG 11/18/08		
APPROVED BY: HMS 12/22/09		
DRAWING NO. 01983C010-00	REFERENCE: SECONDARY ASH SETTLING BASIN	

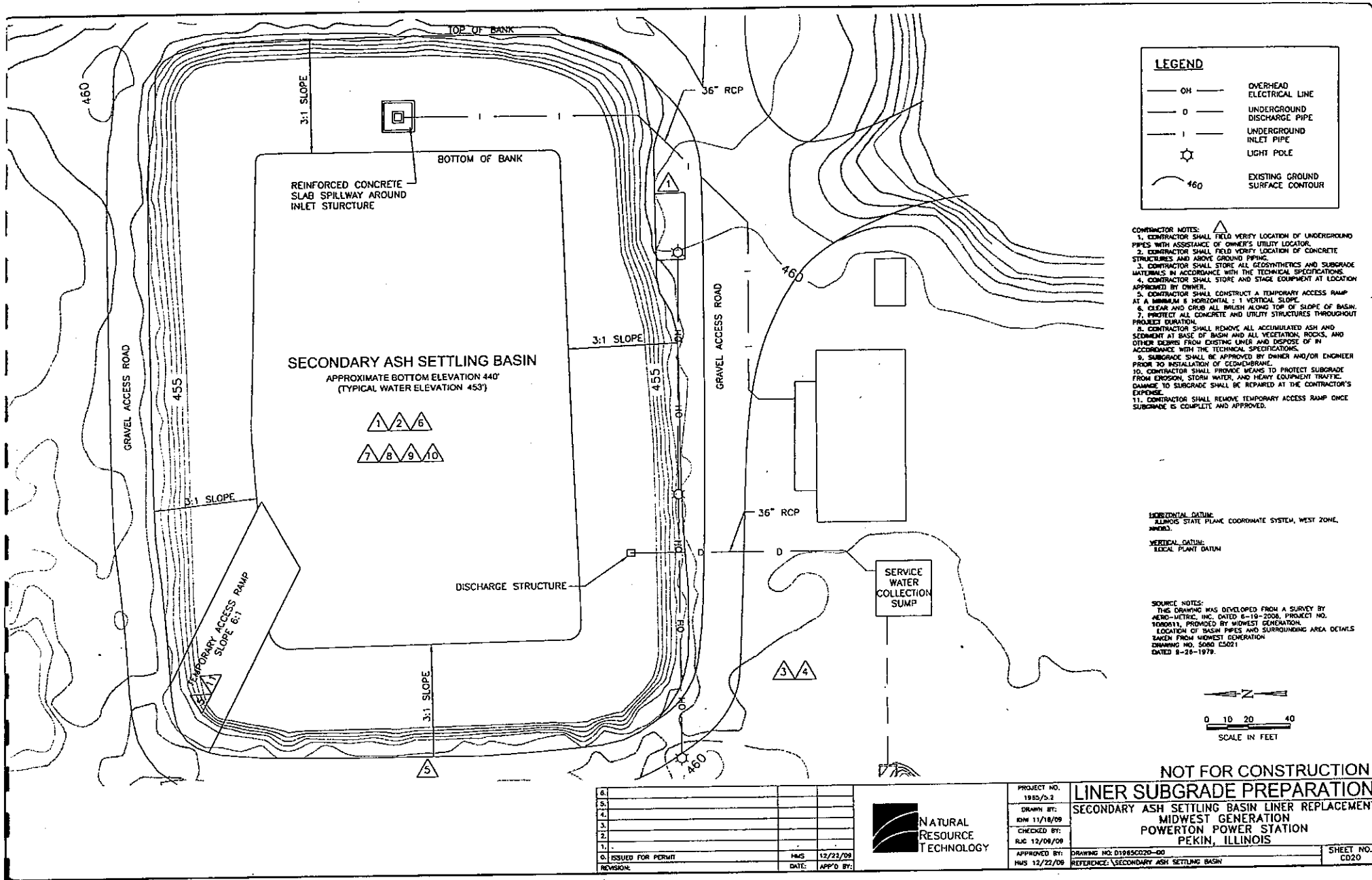

LEGEND

	OVERHEAD ELECTRICAL LINE
	UNDERGROUND DISCHARGE PIPE
	UNDERGROUND INLET PIPE
	LIGHT POLE
	EXISTING GROUND SURFACE CONTOUR

- CONTRACTOR NOTES:**
1. CONTRACTOR SHALL FIELD VERIFY LOCATION OF UNDERGROUND PIPES WITH ASSISTANCE OF OWNER'S UTILITY LOCATOR.
 2. CONTRACTOR SHALL FIELD VERIFY LOCATION OF CONCRETE STRUCTURES AND ABOVE GROUND PIPING.
 3. CONTRACTOR SHALL STORE ALL GEOSYNTHETICS AND SUBGRADE MATERIALS IN ACCORDANCE WITH THE TECHNICAL SPECIFICATIONS.
 4. CONTRACTOR SHALL STORE AND STAGE EQUIPMENT AT LOCATION APPROVED BY OWNER.
 5. CONTRACTOR SHALL CONSTRUCT A TEMPORARY ACCESS RAMP AT A MINIMUM 4 HORIZONTAL : 1 VERTICAL SLOPE.
 6. CLEAR AND CRUSH ALL BRUSH ALONG TOP OF SLOPE OF BASIN.
 7. PROTECT ALL CONCRETE AND UTILITY STRUCTURES THROUGHOUT PROJECT DURATION.
 8. CONTRACTOR SHALL REMOVE ALL ACCUMULATED ASH AND SEDIMENT AT BASE OF BASIN AND ALL VEGETATION, ROCKS, AND OTHER DEBRIS FROM EXISTING LINER AND DISPOSE OF IN ACCORDANCE WITH THE TECHNICAL SPECIFICATIONS.
 9. SUBGRADE SHALL BE APPROVED BY OWNER AND/OR ENGINEER PRIOR TO INSTALLATION OF GEOSYNTHETIC.
 10. CONTRACTOR SHALL PROVIDE MEANS TO PROTECT SUBGRADE FROM EROSION, STORM WATER, AND HEAVY EQUIPMENT TRAFFIC. DAMAGE TO SUBGRADE SHALL BE REPAIRED AT THE CONTRACTOR'S EXPENSE.
 11. CONTRACTOR SHALL REMOVE TEMPORARY ACCESS RAMP ONCE SUBGRADE IS COMPLETE AND APPROVED.

HORIZONTAL DATUM:
ILLINOIS STATE PLANE COORDINATE SYSTEM, WEST ZONE, NAD83

VERTICAL DATUM:
LOCAL PLANT DATUM

SOURCE NOTES:
THIS DRAWING WAS DEVELOPED FROM A SURVEY BY AERO-METRIC, INC. DATED 6-19-2008, PROJECT NO. 1008011, PROVIDED BY MIDWEST GENERATION. LOCATION OF BASIN PIPES AND SURROUNDING AREA DETAILS TAKEN FROM MIDWEST GENERATION DRAWING NO. 5060 C5021 DATED 8-28-1979.

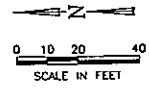

NOT FOR CONSTRUCTION

6.			
5.			
4.			
3.			
2.			
1.			
0.	ISSUED FOR PERMIT	HUS	12/22/09
	REVISION:	DATE:	APP'D BY:



PROJECT NO.	1985/5.2
DRAWN BY:	RJM 11/18/09
CHECKED BY:	RJC 12/08/09
APPROVED BY:	HUS 12/22/09

LINER SUBGRADE PREPARATION
SECONDARY ASH SETTLING BASIN LINER REPLACEMENT
MIDWEST GENERATION
POWERON POWER STATION
PEKIN, ILLINOIS

DRAWING NO. D1985C020-00	SHEET NO. CD20
REFERENCE: SECONDARY ASH SETTLING BASIN	

LEGEND

- OH — OVERHEAD ELECTRICAL LINE
- D — UNDERGROUND DISCHARGE PIPE
- I — UNDERGROUND INLET PIPE
- — ANCHOR TRENCH
- ☼ LIGHT POLE
- ⊠ HDPE GEOMEMBRANE

CONTRACTOR NOTES:

1. CONTRACTOR SHALL INSTALL 80 MIL HDPE, WHITE, TEXTURED GEOMEMBRANE IN ACCORDANCE WITH THE TECHNICAL SPECIFICATION. CONTRACTOR SHALL PROVIDE AND FOLLOW AN APPROVED GEOMEMBRANE LAYOUT PLAN.
2. GEOMEMBRANE SHALL BE ANCHORED INTO 2.5 FEET DEEP TRENCHES ALONG TOP OF BASH BANK, AS SHOWN ON SHEET C031. CONTRACTOR SHALL ADVISE OWNER AND/OR ENGINEER IF PROPOSED LOCATION FOR ANCHOR TRENCH IS NOT POSSIBLE.
3. RESTORE AREAS DISTURBED BY EQUIPMENT AND MATERIAL LAYDOWN.
4. CONTRACTOR SHALL PROVIDE SURVEY DOCUMENTATION OF THE ITEMS LISTED IN THE TECHNICAL SPECIFICATIONS.
5. CONTRACTOR SHALL PERFORM A LEAK LOCATION SURVEY IN ACCORDANCE WITH TECHNICAL SPECIFICATIONS.

SOURCE NOTES:
 THIS DRAWING WAS DEVELOPED FROM A SURVEY BY ACRO-METRIC, INC. DATED 8-15-2008. PROJECT NO. 1008011, PROVIDED BY MIDWEST GENERATION. LOCATION OF BASIN PIPES AND SURROUNDING AREA DETAILS TAKEN FROM MIDWEST GENERATION DRAWING NO. 5080 C5021 DATED 9-26-1979.

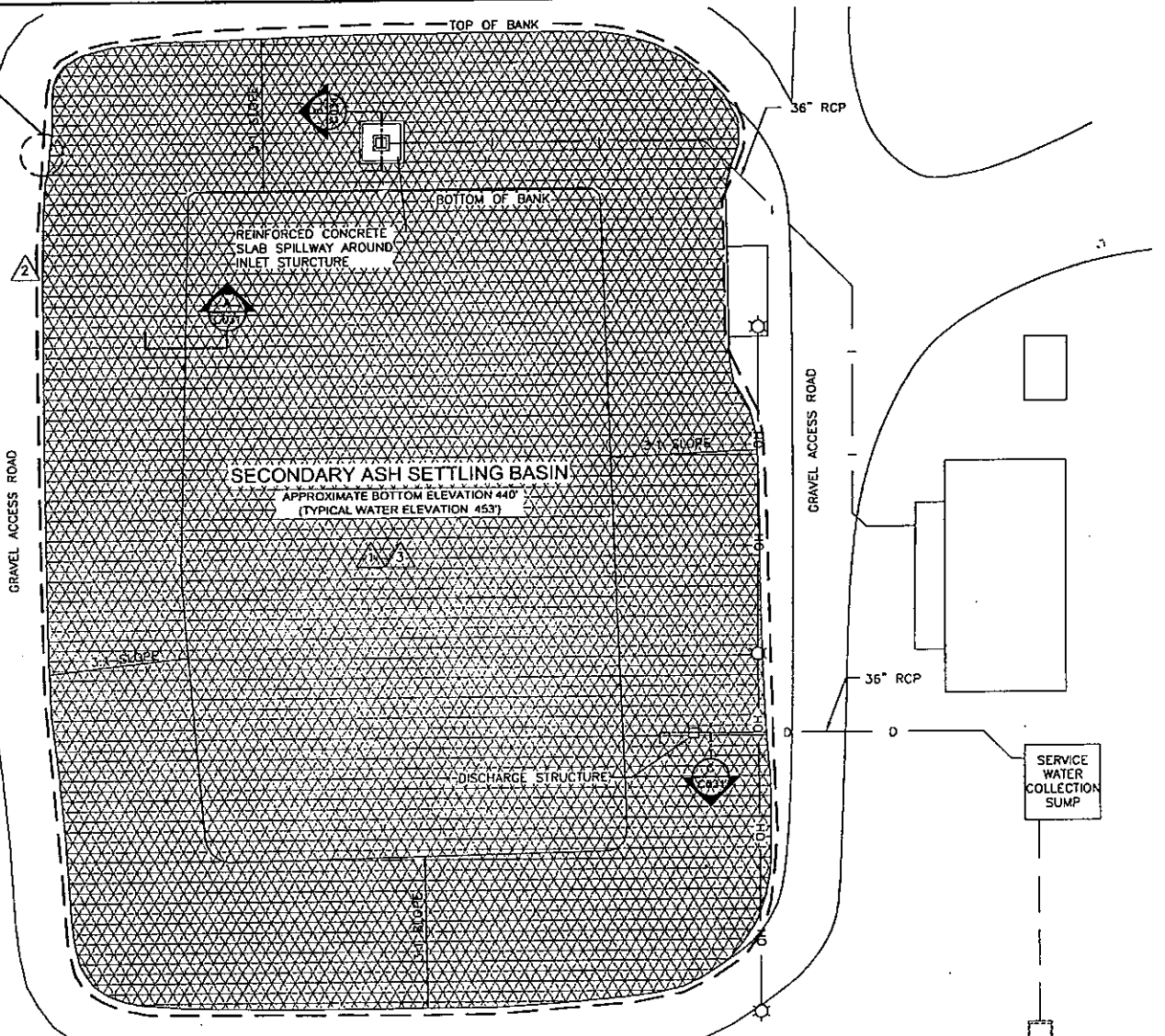
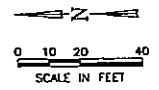

6			
5			
4			
3			
2			
1			
0	ISSUED FOR PERMIT	HMS	12/22/08
	REVISION	DATE:	APP'D BY:



PROJECT NO.
1945/5.2
 DRAWN BY:
JMW 11/25/08
 CHECKED BY:
RJG 12/08/09
 APPROVED BY:
HMS 12/22/08

NOT FOR CONSTRUCTION
GEOMEMBRANE PLAN
 SECONDARY ASH SETTLING BASIN LINER REPLACEMENT
 MIDWEST GENERATION
 POWERTON POWER STATION
 PEKIN, ILLINOIS

DRAWING NO: D1945C030-00
 REFERENCE: SECONDARY ASH SETTLING BASIN

SHEET NO.
C030

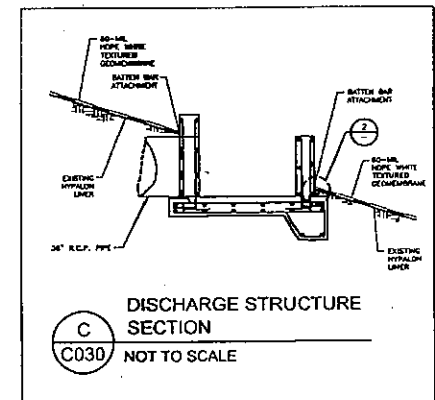
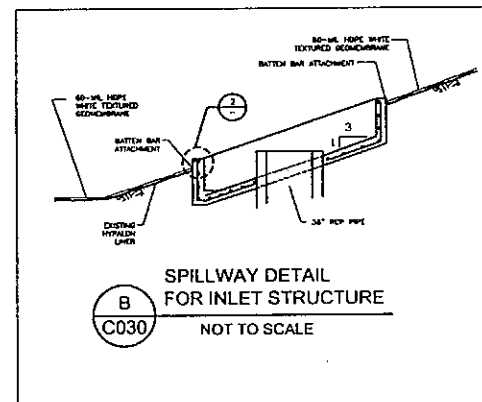
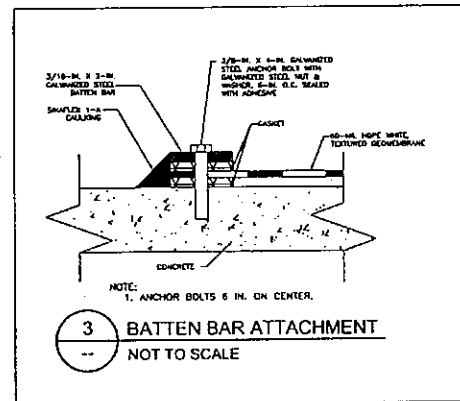
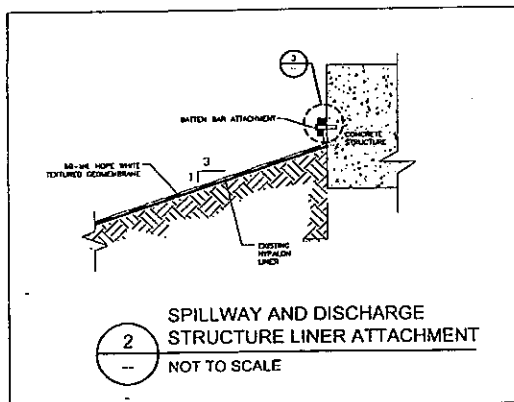
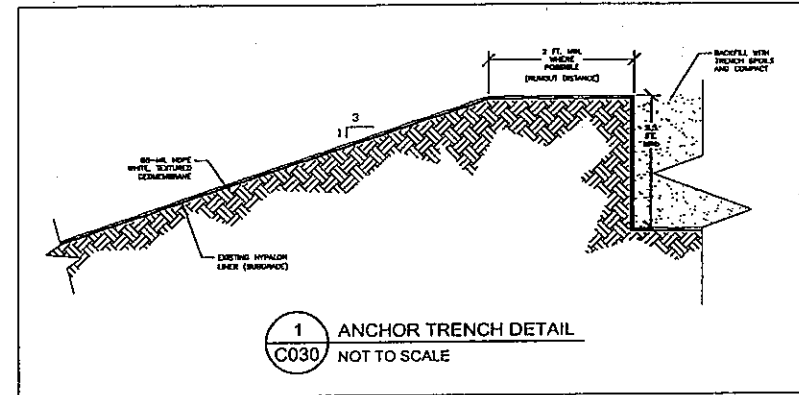
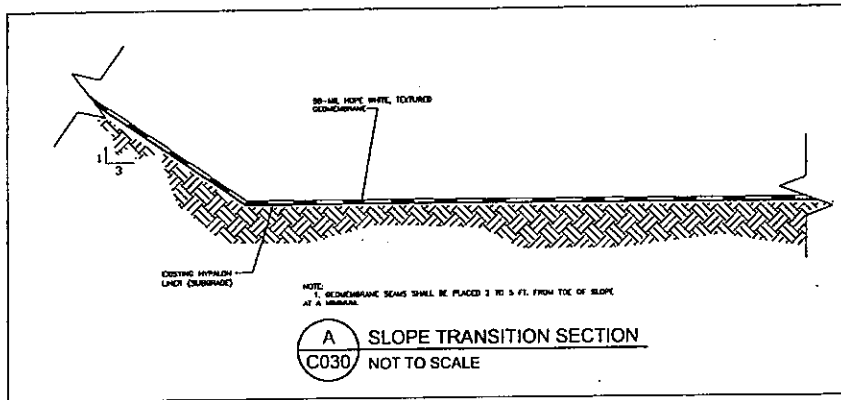

NOT FOR CONSTRUCTION

DETAILS AND SECTIONS

SECONDARY ASH SETTLING BASIN LINER REPLACEMENT
MIDWEST GENERATION
POWERON POWER STATION
PEKIN, ILLINOIS

6.			
5.			
4.			
3.			
2.			
1.			
D. ISSUED FOR PERMIT	HMS	12/22/09	
REVISION:	DATE:	APP'D BY:	



PROJECT NO.	1985/5.2
DRAWN BY:	KMW 11/30/09
CHECKED BY:	RJC 12/18/09
APPROVED BY:	HMS 12/22/09

DRAWING NO: D1985C031-00	SHEET NO. C031
REFERENCE: SECONDARY ASH SETTLING BASIN	

MWG13-15_9731